



Prices effective February 5, 2018

Published June 2018

Everywhere™ Tables

Introduction	page 2
Everywhere™ Tables	3
Standard-Height Tables	5
Standard-Height Table Legs and Bases	57
Standing-Height Tables	60
Occasional Tables	66
Power and Data Support	72
Accessories	90
Indices	123
By Name	123
By Number	125
Appendices	
20-Day or Less/Assigned Lead-Time Order Information	
Vary Easy Program	
Stain-to-Match Program	
For the latest materials information, refer to the Materials pages on HermanMiller.com.	

Introduction

A Note on the Organization of This Book

There are a few signals that will help you understand the organization of this book. Once you know them, you should be able to find your way around easily.

Like a newspaper, this book is formatted with columns of text and illustrations that run vertically.

Information wraps from one column to the next and continues for as many pages as it needs to.

Black bars are clues.

A black bar at the top of a page signals the start of information about a product.

This information is divided into two sections, each signaled by a black bar. Product Information includes a description, additional notes, and dimensional drawings. Specification Information, which always begins at the top of a column, includes a series of steps. Each step represents a decision you need to make in order to complete your product number. Steps must be followed sequentially. The number of pages needed to complete information on a product varies; some will be complete in one page; others may fill three or four pages. Just continue going through the steps until you run into the next product, signaled by the black bar at the top of the page.

Black tabs running along the outside edge of the page help you locate what section you are in or what section you want to go to. You can thumb forwards or backwards to find a section; tabs and text appear on both sides of the page.

The additional pages in the back of the book include the appendices and indices. They are signaled by a long black bar running along the outside edge of the page.

The index is presented two ways.

The first index is in alphabetical order by product name. It can be helpful if you are new to the products and numbering scheme or if you are looking for a type of product, such as work chair or round table.

The second index is by product number. It lists, in alphanumeric order, the base product number, typically a five-digit number.

General Information

This book is effective February 5, 2018, subject to change without notice. Products may be purchased from authorized Herman Miller dealers who will quote prices upon request. For more information about our products and services or to see a list of dealers, visit www.HermanMiller.com.

All prices are list prices. Additional services, such as planning services, design, storage, and installation, are not included and must be added to these prices when the additional services are requested.

Illustrations, specifications, and prices are based on the latest information at the time of publication. The right is reserved to make changes at any time without notice in prices, fabrics, finishes, materials, specifications, and models, and also to discontinue models and finishes.

Dimensions shown in the drawings are engineering drawing dimensions rounded up to the nearest $\frac{1}{8}$ ". Product is shipped set up or knocked down. Products that include "Shipped knocked down" in the description require some assembly. If this statement does not appear in the description, the product is shipped assembled.

Service problems are normally handled by a Herman Miller authorized dealer. Where this cannot be accomplished on a local level, service problems should be referred to the Customer Care Representative for your region, Herman Miller, Inc., Zeeland, Michigan 49464.

20-Day or Less/Assigned Lead-Time Shipments

All products and options in this price book not designated by an Assigned Program icon  will ship in **20 business days or less** after being acknowledged by Herman Miller.

Products and options designated by an  are on the assigned lead-time program and may ship in 20 days, less than 20 days, or more than 20 days from order acknowledgement.

Standard-Height Tables

Standard-Height Table Legs and Bases

Standing-Height Tables

Occasional Tables

Power and Data Support

Accessories



Rectangular Table

DT1AE.
DT1AS.
DT1AT.

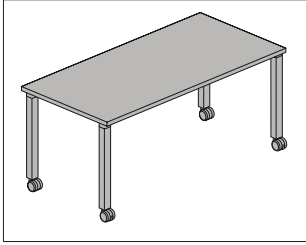

Product Information

Description

This rectangular table comes in multiple edge styles and has a laminate top with thermoplastic edge, laminate top with a thermoplastic backed plywood edge, veneer top and edge, or painted top and edge. It has multiple leg options, and is available with casters or glides. The caster option has 2 locking and 2 non-locking casters. Glides have 1/2" leveling range. Shipped knocked down.

Height-adjustable legs have a 5" range in 1" increments.

Notes

18" depth available with square edge only.

C-leg and D-leg cannot be used with either the 18" deep or 36" deep tops.

When specifying grommets (253, 254, 255), cutouts will be located in the center of table.

Cutouts available for all Connect™ power and data accessories (see Thrive® Portfolio). Cutouts will be located in the center, laterally, and approximately 3" from the rear edge of surface.

Reinforcement channels are used under table tops 54" and wider. They will be located along the center line for 18" deep and 24" deep surfaces, and 19" from the front edge for 30" deep surfaces.

For additional details on available edge options see Appendices.

For additional size, edge, finish, and cable management options, see Vary Easy Program in Appendices.

Note: UL listed when used with Connect single circuit electrical product (Y137x.) with post leg (P), T-leg (T) and C-leg (C) options.

Dimensions

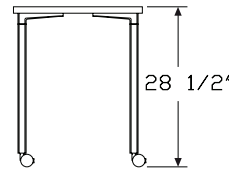
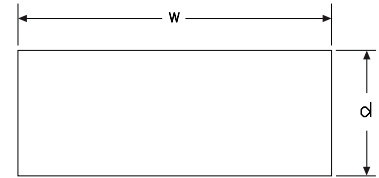

P

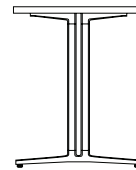

T

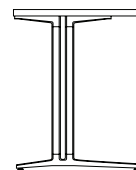

C

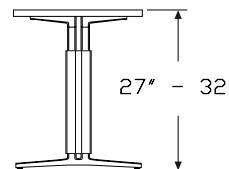

A

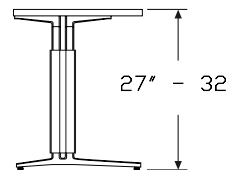

D



Rectangular Table *continued*

Specification Information	
Step 1.	
DT1A	
Step 2. Edge	
S.	squared-edge
T.	thin-edge
E.	eased-edge
Step 3. Depth	
<i>For squared-edge (S.)</i>	
18	18" deep
24	24" deep
30	30" deep
36	36" deep
<i>For thin-edge (T.) or eased-edge (E.)</i>	
24	24" deep
30	30" deep
36	36" deep
Step 4. Width	
<i>For 18" deep (18)</i>	
48	48" wide
60	60" wide
72	72" wide
<i>For 24" deep (24) or 30" deep (30)</i>	
36	36" wide
42	42" wide
48	48" wide
54	54" wide
60	60" wide
66	66" wide
72	72" wide
<i>For 36" deep (36)</i>	
42	42" wide
48	48" wide
54	54" wide
60	60" wide
66	66" wide
72	72" wide

Step 5. Surface Material	
<i>For squared-edge (S.)</i>	
L	lamine top/thermoplastic edge
U	lamine top/universal edge
W	veneer top/veneer edge A
P	painted Formcoat® top/edge
<i>For thin-edge (T.)</i>	
W	veneer top/veneer edge A
P	painted Formcoat® top/edge
<i>For eased-edge (E.)</i>	
P	painted Formcoat® top/edge
Step 6. Leg Type	
<i>For 18" deep (18) or 36" deep (36)</i>	
P	post leg
T	T-leg
A	T-leg with height adjustment
<i>For 24" deep (24) or 30" deep (30)</i>	
P	post leg
T	T-leg
A	T-leg with height adjustment
C	C-leg
D	C-leg with height adjustment

Prices for Steps 1-6.							
		LP	LT	LA	LC	LD	UP
DT1AS. 18	48	\$726	942	1179	—	—	726
	60	\$798	1037	1295	—	—	798
	72	\$861	1118	1399	—	—	861
	24 36	\$726	942	1179	942	1179	726
	42	\$762	991	1237	991	1237	762
	48	\$799	1039	1299	1039	1299	799
	54	\$848	1102	1375	1102	1375	848
	60	\$898	1167	1457	1167	1457	898
	66	\$961	1250	1561	1250	1561	961
	72	\$1030	1337	1669	1337	1669	1030

Rectangular Table *continued*

Everywhere™ Standard-Height Tables

30 36	\$754	979	1224	979	1224	754
42	\$792	1030	1287	1030	1287	792
48	\$833	1081	1349	1081	1349	833
54	\$882	1145	1431	1145	1431	882
60	\$935	1214	1517	1214	1517	935
66	\$1000	1299	1622	1299	1622	1000
72	\$1070	1388	1737	1388	1737	1070
36 42	\$864	1112	1400	—	—	864
48	\$876	1104	1412	—	—	876
54	\$957	1189	1493	—	—	957
60	\$975	1203	1506	—	—	975
66	\$1029	1319	1660	—	—	1029
72	\$1096	1401	1763	—	—	1096
	UT	UA	UC	UD	WP	WT
DT1AS. 18 48	\$942	1179	—	—	885	1167
60	\$1037	1295	—	—	978	1290
72	\$1118	1399	—	—	1062	1397
24 36	\$942	1179	942	1179	885	1167
42	\$991	1237	991	1237	931	1228
48	\$1039	1299	1039	1299	981	1292
54	\$1102	1375	1102	1375	1042	1373
60	\$1167	1457	1167	1457	1109	1457
66	\$1250	1561	1250	1561	1190	1564
72	\$1337	1669	1337	1669	1277	1677
30 36	\$979	1224	979	1224	923	1216
42	\$1030	1287	1030	1287	969	1278
48	\$1081	1349	1081	1349	1024	1346
54	\$1145	1431	1145	1431	1086	1430
60	\$1214	1517	1214	1517	1155	1519
66	\$1299	1622	1299	1622	1240	1628
72	\$1388	1737	1388	1737	1333	1746
36 42	\$1112	1400	—	—	1240	1492
48	\$1104	1412	—	—	1272	1516
54	\$1189	1493	—	—	1375	1623
60	\$1203	1506	—	—	1420	1670
66	\$1319	1660	—	—	1610	2001
72	\$1401	1763	—	—	1686	2220
	WA	WC	WD	PP	PT	PA
DT1AS. 18 48	\$1471	—	—	836	1084	1355
60	\$1624	—	—	920	1193	1490
72	\$1760	—	—	993	1288	1607

24 36	\$1471	1167	1471	836	1084	1355
42	\$1549	1228	1549	876	1139	1421
48	\$1628	1292	1628	921	1195	1494
54	\$1730	1373	1730	974	1266	1583
60	\$1838	1457	1838	1035	1343	1676
66	\$1970	1564	1970	1106	1438	1795
72	\$2111	1677	2111	1184	1536	1919
30 36	\$1533	1216	1533	866	1127	1410
42	\$1613	1278	1613	912	1184	1481
48	\$1696	1346	1696	958	1243	1552
54	\$1801	1430	1801	1012	1316	1645
60	\$1913	1519	1913	1076	1397	1745
66	\$2051	1628	2051	1150	1494	1865
72	\$2198	1746	2198	1231	1598	1996
36 42	\$1755	—	—	996	1279	1608
48	\$1785	—	—	1008	1269	1624
54	\$1889	—	—	1101	1368	1715
60	\$1960	—	—	1122	1384	1732
66	\$2286	—	—	1139	1490	1890
72	\$2565	—	—	1153	1610	2026
				PC	PD	
DT1AS. 24 36				\$1084	1355	
42				\$1139	1421	
48				\$1195	1494	
54				\$1266	1583	
60				\$1343	1676	
66				\$1438	1795	
72				\$1536	1919	
30 36				\$1127	1410	
42				\$1184	1481	
48				\$1243	1552	
54				\$1316	1645	
60				\$1397	1745	
66				\$1494	1865	
72				\$1598	1996	
	UT	UA	UC	UD	WP	WT
DT1AT. 24 36	—	—	—	—	\$1062	1403
42	—	—	—	—	\$1116	1473
48	—	—	—	—	\$1179	1551
54	—	—	—	—	\$1252	1649
60	—	—	—	—	\$1331	1749
66	—	—	—	—	\$1428	1876
72	—	—	—	—	\$1532	2014

Rectangular Table *continued*

Everywhere™ Standard-Height Tables

30 36	—	—	—	—	\$1106	1458
42	—	—	—	—	\$1164	1533
48	—	—	—	—	\$1228	1615
54	—	—	—	—	\$1303	1714
60	—	—	—	—	\$1386	1823
66	—	—	—	—	\$1489	1953
72	—	—	—	—	\$1598	2095

36 42	—	—	—	—	\$1489	1790
48	—	—	—	—	\$1526	1818
54	—	—	—	—	\$1652	1947
60	—	—	—	—	\$1705	2005
66	—	—	—	—	\$1932	2400
72	—	—	—	—	\$2021	2664

	WA	WC	WD	PP	PT	PA
DT1AT. 24 36	\$1766	1403	1766	890	1155	1444
42	\$1858	1473	1858	934	1212	1515
48	\$1953	1551	1953	978	1272	1592
54	\$2076	1649	2076	1038	1348	1686
60	\$2204	1749	2204	1102	1431	1785
66	\$2363	1876	2363	1179	1529	1912
72	\$2533	2014	2533	1260	1636	2045

30 36	\$1841	1458	1841	925	1200	1501
42	\$1935	1533	1935	971	1260	1575
48	\$2034	1615	2034	1020	1324	1654
54	\$2162	1714	2162	1080	1404	1753
60	\$2295	1823	2295	1145	1488	1858
66	\$2461	1953	2461	1223	1592	1986
72	\$2637	2095	2637	1309	1702	2126

36 42	\$2106	—	—	1059	1363	1713
48	\$2144	—	—	1075	1351	1729
54	\$2265	—	—	1173	1456	1828
60	\$2353	—	—	1195	1476	1845
66	\$2744	—	—	1239	1540	2057
72	\$3076	—	—	1333	1726	2160

	PC	PD
DT1AT. 24 36	\$1155	1444
42	\$1212	1515
48	\$1272	1592
54	\$1348	1686
60	\$1431	1785
66	\$1529	1912
72	\$1636	2045

30 36						\$1200	1501
42						\$1260	1575
48						\$1324	1654
54						\$1404	1753
60						\$1488	1858
66						\$1592	1986
72						\$1702	2126

	WA	WC	WD	PP	PT	PA
DT1AE. 24 36	—	—	—	\$890	1155	1444
42	—	—	—	\$934	1212	1515
48	—	—	—	\$978	1272	1592
54	—	—	—	\$1038	1348	1686
60	—	—	—	\$1102	1431	1785
66	—	—	—	\$1179	1529	1912
72	—	—	—	\$1260	1636	2045

30 36	—	—	—	\$925	1200	1501
42	—	—	—	\$971	1260	1575
48	—	—	—	\$1020	1324	1654
54	—	—	—	\$1080	1404	1753
60	—	—	—	\$1145	1488	1858
66	—	—	—	\$1223	1592	1986
72	—	—	—	\$1309	1702	2126

36 42	—	—	—	\$1059	1363	1713
48	—	—	—	\$1075	1351	1729
54	—	—	—	\$1173	1456	1828
60	—	—	—	\$1195	1476	1845
66	—	—	—	\$1248	1623	2075
72	—	—	—	\$1338	1736	2160

	PC	PD
DT1AE. 24 36	\$1155	1444
42	\$1212	1515
48	\$1272	1592
54	\$1348	1686
60	\$1431	1785
66	\$1529	1912
72	\$1636	2045

30 36	\$1200	1501
42	\$1260	1575
48	\$1324	1654
54	\$1404	1753
60	\$1488	1858
66	\$1592	1986
72	\$1702	2126

Step 7.

Top Finish		
<i>For laminate top/thermoplastic edge (L) or laminate top/universal edge (U)</i>		
76	light brown walnut	+\$0
91	white	+\$0
98	studio white	+\$0
8Q	folkstone grey	+\$0
CL	cool grey neutral	+\$0
HF	inner tone light	+\$0
HM	natural maple	+\$0
HP	light anigre	+\$0
HT	inner tone	+\$0
HX	aged cherry	+\$0
HY	walnut on cherry	+\$0
LA	light ash	+\$0
LBA	clear on ash	+\$0
LBR	phantom ecru	+\$0
LBS	phantom cocoa	+\$0
LBU	medium matte walnut	+\$0
LBV	warm grey teak	+\$0
LBB	oak on ash	+\$0
LBC	walnut on ash	+\$0
LBD	dark brown walnut	+\$0
LBE	medium red walnut	+\$0
LBF	neutral twill	+\$0
LBG	sarum twill	+\$0
LBH	earthen twill	+\$0
LBJ	graphite twill	+\$0
LBK	pewter mesh	+\$0
LBL	steel mesh	+\$0
LBM	crisp linen	+\$0
LBN	classic linen	+\$0
LBP	casual linen	+\$0
LBQ	white twill	+\$0
LU	soft white	+\$0
WL	sandstone	+\$0
WN	warm grey neutral	+\$0

Top/Edge Finish: Wood Veneer

<i>For veneer top/veneer edge (W)</i>		
2U	light brown walnut A	+\$50
40	dark brown walnut A	+\$50
ED	aged cherry A	+\$50
EK	medium red walnut A	+\$50
EW	medium matte walnut A	+\$50
ET	clear on ash A	+\$50
EU	oak on ash A	+\$50
EV	walnut on ash A	+\$50
UL	natural maple A	+\$50
UX	walnut on cherry A	+\$50

Top/Edge Finish: Opaque Formcoat®

<i>For painted Formcoat® top/edge (P)</i>		
8Q	folkstone grey	+\$0
91	white	+\$0
CL	cool grey neutral	+\$0
LU	soft white	+\$0
WL	sandstone	+\$0
WN	warm grey neutral	+\$0

Step 8. Edge Finish

<i>For laminate top/thermoplastic edge (L)</i>		
76	light brown walnut	+\$0
8Q	folkstone grey	+\$0
91	white	+\$0
98	studio white	+\$0
CL	cool grey neutral	+\$0
LA	light ash	+\$0
LBA	clear on ash	+\$0
LBR	phantom ecru	+\$0
LBS	phantom cocoa	+\$0
LBU	medium matte walnut	+\$0
LBV	warm grey teak	+\$0
LBB	oak on ash	+\$0
LBC	walnut on ash	+\$0
LBD	dark brown walnut	+\$0
LBE	medium red walnut	+\$0
LBF	neutral twill	+\$0
LBG	sarum twill	+\$0
LBH	earthen twill	+\$0
LBJ	graphite twill	+\$0
LBK	pewter mesh	+\$0
LBL	steel mesh	+\$0
LBM	crisp linen	+\$0

Rectangular Table *continued*

Everywhere™ Standard-Height Tables

LBN	classic linen	+\$0
LBP	casual linen	+\$0
LBQ	white twill	+\$0
WL	sandstone	+\$0
WN	warm grey neutral	+\$0
HF	inner tone light	+\$0
HM	natural maple	+\$0
HP	light anigre	+\$0
HT	inner tone	+\$0
HX	aged cherry	+\$0
HY	walnut on cherry	+\$0
LU	soft white	+\$0
9V	tapestry beige	+\$0

For laminate top/universal edge (U)

PLY	plywood edge	+\$50
------------	--------------	-------

Step 9. Leg Finish

8Q	folkstone grey	+\$0
91	white	+\$0
98	studio white A	+\$0
BU	black umber	+\$0
CL	cool grey neutral	+\$0
G2	graphite satin	+\$0
HF	inner tone light	+\$0
LU	soft white	+\$0
MT	medium tone	+\$0
SG	slate grey	+\$0
WL	sandstone	+\$0
WN	warm grey neutral	+\$0
CN	metallic champagne	+\$0
EH	metallic bronze	+\$0
MS	metallic silver	+\$0
CD	polished aluminum	+\$110

Step 10. Casters/Glides

20	casters	+\$0
57	glides	+\$0

Step 11. Grommets

For squared-edge (S.) with 18" deep (18)

NTG	no grommet	+\$0
------------	------------	------

For 24" deep (24), 30" deep (30) AND 36" deep (36)

NTG	no grommet	+\$0
253	cutout for Y1420. or Y1425. - 3 port	+\$27
254	cutout for Y1420. or Y1425. - 5 port	+\$27
255	cutout for Y1420. or Y1425. - 6 port	+\$27

Square Table

DT1BE.
DT1BS.
DT1BT.

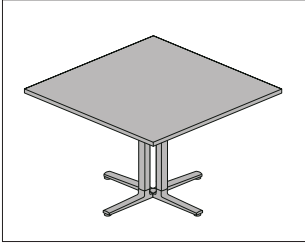

Product Information

Description

This square table comes in multiple edge styles and has a laminate top with thermoplastic edge, laminate top with a thermoplastic backed plywood edge, veneer top and edge, or painted top and edge. It has multiple leg/base options, and is available with casters or glides. The caster option has 2 locking and 2 non-locking casters. Glides have 1/2" leveling range. Shipped knocked down.

Notes

48" tops available only with post leg option for optimum stability.

42" top (4242) with 4-column base (X) available only with glides.

Casters are not compatible with this top/base combination.

For additional details on available edge options see Appendices.

For additional size, edge, and finish options, see Vary Easy Program in Appendices.

UL listed when used with Connect™ single circuit electrical product (Y137x.) with post leg (P) option.

Dimensions

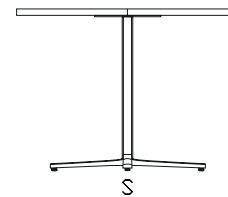
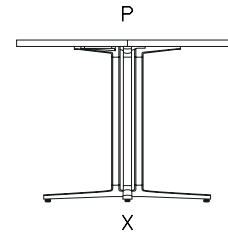
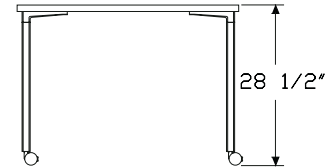
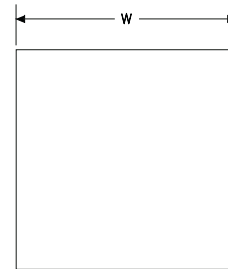

Square Table *continued*

Everywhere™ Standard-Height Tables

Specification Information	
Step 1.	
DT1B	
Step 2. Edge	
S.	squared-edge
T.	thin-edge
E.	eased-edge
Step 3. Depth/Width	
3030	30" deep x 30" wide
3636	36" deep x 36" wide
4242	42" deep x 42" wide
4848	48" deep x 48" wide
Step 4. Surface Material	
<i>For squared-edge (S.)</i>	
L	lamine top/thermoplastic edge
U	lamine top/universal edge
W	veneer top/veneer edge <input type="checkbox"/>
P	painted Formcoat® top/edge
<i>For thin-edge (T.)</i>	
W	veneer top/veneer edge <input type="checkbox"/>
P	painted Formcoat® top/edge
<i>For eased-edge (E.)</i>	
P	painted Formcoat® top/edge
Step 5. Leg/Base Type	
<i>For 30" deep x 30" wide (3030)</i>	
P	post leg
X	4-column base
S	single-column base <input type="checkbox"/>
<i>For 36" deep x 36" wide (3636)</i>	
P	post leg
X	4-column base
S	single-column base <input type="checkbox"/>
<i>For 42" deep x 42" wide (4242)</i>	
P	post leg
X	4-column base

<i>For 48" deep x 48" wide (4848)</i>				
P post leg				
Prices for Steps 1-5.				
		P	X	S
DT1BS. 3030	L	\$690	896	762
	U	\$690	896	762
	W	\$872	1150	968
	P	\$794	1032	876
3636	L	\$828	1075	914
	U	\$828	1075	914
	W	\$1058	1391	1176
	P	\$953	1236	1050
4242	L	\$951	1235	—
	U	\$951	1235	—
	W	\$1223	1607	—
	P	\$1093	1419	—
4848	L	\$1065	—	—
	U	\$1065	—	—
	W	\$1436	—	—
	P	\$1224	—	—
		P	X	S
DT1BT. 3030	W	\$1045	1380	1163
	P	\$847	1100	934
3636	W	\$1269	1669	1410
	P	\$1013	1315	1118
4242	W	\$1468	1930	—
	P	\$1164	1513	—
4848	W	\$1723	—	—
	P	\$1304	—	—
		P	X	S
DT1BE. 3030	P	\$847	1100	934
3636	P	\$1013	1315	1118
4242	P	\$1164	1513	—
4848	P	\$1304	—	—

Square Table *continued*

Step 6.

Top Finish

For laminate top/thermoplastic edge (L) or laminate top/universal edge (U)

76	light brown walnut	+\$0
91	white	+\$0
98	studio white	+\$0
8Q	folkstone grey	+\$0
CL	cool grey neutral	+\$0
HF	inner tone light	+\$0
HM	natural maple	+\$0
HP	light anigre	+\$0
HT	inner tone	+\$0
HX	aged cherry	+\$0
HY	walnut on cherry	+\$0
LA	light ash	+\$0
LBA	clear on ash	+\$0
LBR	phantom ecru	+\$0
LBS	phantom cocoa	+\$0
LBU	medium matte walnut	+\$0
LBV	warm grey teak	+\$0
LBB	oak on ash	+\$0
LBC	walnut on ash	+\$0
LBD	dark brown walnut	+\$0
LBE	medium red walnut	+\$0
LBF	neutral twill	+\$0
LBG	sarum twill	+\$0
LBH	earthen twill	+\$0
LBJ	graphite twill	+\$0
LBK	pewter mesh	+\$0
LBL	steel mesh	+\$0
LBM	crisp linen	+\$0
LBN	classic linen	+\$0
LBP	casual linen	+\$0
LBQ	white twill	+\$0
LU	soft white	+\$0
WL	sandstone	+\$0
WN	warm grey neutral	+\$0

Top/Edge Finish: Wood Veneer

For veneer top/veneer edge (W)

2U	light brown walnut A	+\$50
40	dark brown walnut A	+\$50
ED	aged cherry A	+\$50
EK	medium red walnut A	+\$50
EW	medium matte walnut A	+\$50
ET	clear on ash A	+\$50
EU	oak on ash A	+\$50
EV	walnut on ash A	+\$50
UL	natural maple A	+\$50
UX	walnut on cherry A	+\$50

Top/Edge Finish: Opaque Formcoat®

For painted Formcoat® top/edge (P)

8Q	folkstone grey	+\$0
91	white	+\$0
CL	cool grey neutral	+\$0
LU	soft white	+\$0
WL	sandstone	+\$0
WN	warm grey neutral	+\$0

Square Table *continued*

Step 7. Edge Finish

For laminate top/thermoplastic edge (L)

76	light brown walnut	+\$0
8Q	folkstone grey	+\$0
91	white	+\$0
98	studio white	+\$0
CL	cool grey neutral	+\$0
LA	light ash	+\$0
LBA	clear on ash	+\$0
LBR	phantom ecru	+\$0
LBS	phantom cocoa	+\$0
LBU	medium matte walnut	+\$0
LBV	warm grey teak	+\$0
LBB	oak on ash	+\$0
LBC	walnut on ash	+\$0
LBD	dark brown walnut	+\$0
LBE	medium red walnut	+\$0
LBF	neutral twill	+\$0
LBG	sarum twill	+\$0
LBH	earthen twill	+\$0
LBJ	graphite twill	+\$0
LBK	pewter mesh	+\$0
LBL	steel mesh	+\$0
LBM	crisp linen	+\$0
LBN	classic linen	+\$0
LBP	casual linen	+\$0
LBQ	white twill	+\$0
WL	sandstone	+\$0
WN	warm grey neutral	+\$0
HF	inner tone light	+\$0
HM	natural maple	+\$0
HP	light anigre	+\$0
HT	inner tone	+\$0
HX	aged cherry	+\$0
HY	walnut on cherry	+\$0
LU	soft white	+\$0

For laminate top/universal edge (U)

PLY	plywood edge	+\$50
------------	--------------	-------

Step 8. Leg Finish

8Q	folkstone grey	+\$0
91	white	+\$0
98	studio white A	+\$0
BU	black umber	+\$0
CL	cool grey neutral	+\$0
G2	graphite satin	+\$0
HF	inner tone light	+\$0
LU	soft white	+\$0
MT	medium tone	+\$0
SG	slate grey	+\$0
WL	sandstone	+\$0
WN	warm grey neutral	+\$0
CN	metallic champagne	+\$0
EH	metallic bronze	+\$0
MS	metallic silver	+\$0
CD	polished aluminum	+\$110

Step 9. Casters/Glides

20	casters	+\$0
57	glides	+\$0

For 4-column base (X)

57	glides	+\$0
-----------	--------	------

Round Table

DT1CE.
DT1CS.
DT1CT.

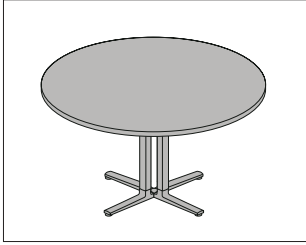

Product Information

Description

This round table comes in multiple edge styles and has a laminate top with thermoplastic edge, veneer top and edge, or painted top and edge. It has multiple leg/base options, and is available with casters or glides. The caster option has 2 locking and 2 non-locking casters. Glides have 1/2" leveling range. Shipped knocked down.

Notes

48" and 60" tops available only with post leg option for optimum stability.

For additional details on available edge options see Appendices.

For additional size, edge, and finish options, see Vary Easy Program in Appendices.

UL listed when used with Connect™ single circuit electrical product (Y137x.) with post leg (P) option.

Dimensions

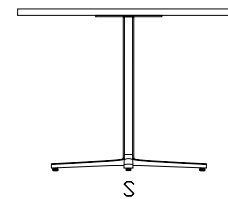
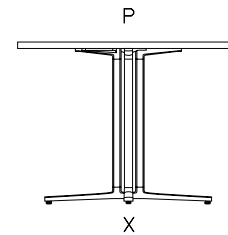
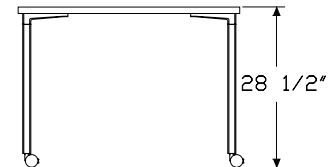
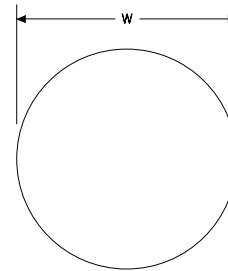

Round Table *continued*

Specification Information

Step 1.

DT1C

Step 2. Edge

- S.** squared-edge
- T.** thin-edge
- E.** eased-edge

Step 3. Diameter

- 30** 30" diameter
- 36** 36" diameter
- 42** 42" diameter
- 48** 48" diameter
- 60** 60" diameter

Step 4. Surface Material

For squared-edge (S.)

- L** laminate top/thermoplastic edge
- W** veneer top/veneer edge **A**
- P** painted Formcoat® top/edge

For thin-edge (T.)

- W** veneer top/veneer edge **A**
- P** painted Formcoat® top/edge

For eased-edge (E.)

- P** painted Formcoat® top/edge

Step 5. Leg/Base Type

For 30" diameter (30) or 36" diameter (36)

- P** post leg
- X** 4-column base
- S** single-column base **A**

For 42" diameter (42)

- P** post leg
- X** 4-column base

For 48" diameter (48) or 60" diameter (60)

- P** post leg

Prices for Steps 1-5.

	P	X	S
DT1CS. 30 L	\$792	1032	876
W	\$1003	1322	1113
P	\$912	1186	1008
36 L	\$953	1235	1005
W	\$1003	1600	1350
P	\$1096	1419	1156
42 L	\$1093	1357	—
W	\$1408	1849	—
P	\$1257	1561	—
48 L	\$1223	—	—
W	\$1651	—	—
P	\$1409	—	—
60 L	\$1335	—	—
W	\$1808	—	—
P	\$1533	—	—

	P	X	S
DT1CT. 30 W	\$1203	1587	1337
P	\$971	1263	1075
36 W	\$1203	1919	1620
P	\$1166	1513	1232
42 W	\$1689	2218	—
P	\$1340	1663	—
48 W	\$1980	—	—
P	\$1499	—	—
60 W	\$2169	—	—
P	\$1634	—	—

	P	X	S
DT1CE. 30 P	\$971	1263	1075
36 P	\$1166	1513	1232
42 P	\$1340	1663	—
48 P	\$1499	—	—
60 P	\$1634	—	—

Step 6.

Top Finish

For laminate top/thermoplastic edge (L)

- 38** twilight +\$0
- 39** desert +\$0
- 76** light brown walnut +\$0
- 91** white +\$0
- 98** studio white +\$0
- 8Q** folkstone grey +\$0

CL	cool grey neutral	+\$0
HF	inner tone light	+\$0
HM	natural maple	+\$0
HP	light anigre	+\$0
HT	inner tone A	+\$0
HX	aged cherry	+\$0
HY	walnut on cherry	+\$0
LA	light ash	+\$0
LBA	clear on ash	+\$0
LBR	phantom ecru	+\$0
LBS	phantom cocoa	+\$0
LBU	medium matte walnut	+\$0
LBV	warm grey teak	+\$0
LBB	oak on ash	+\$0
LBC	walnut on ash	+\$0
LBD	dark brown walnut	+\$0
LBE	medium red walnut	+\$0
LBF	neutral twill	+\$0
LBG	sarum twill	+\$0
LBH	earthen twill	+\$0
LBJ	graphite twill	+\$0
LBK	pewter mesh	+\$0
LBL	steel mesh	+\$0
LBM	crisp linen	+\$0
LBN	classic linen	+\$0
LBP	casual linen	+\$0
LBQ	white twill	+\$0
LU	soft white	+\$0
WL	sandstone	+\$0
WN	warm grey neutral	+\$0

Top/Edge Finish: Wood Veneer
For veneer top/veneer edge (W)

2U	light brown walnut A	+\$50
40	dark brown walnut A	+\$50
ED	aged cherry A	+\$50
EK	medium red walnut A	+\$50
EW	medium matte walnut A	+\$50
ET	clear on ash A	+\$50
EU	oak on ash A	+\$50
EV	walnut on ash A	+\$50
UL	natural maple A	+\$50
UX	walnut on cherry A	+\$50

Top/Edge Finish: Opaque Formcoat®
For painted Formcoat® top/edge (P)

8Q	folkstone grey	+\$0
91	white	+\$0
CL	cool grey neutral	+\$0
LU	soft white	+\$0
WL	sandstone	+\$0
WN	warm grey neutral	+\$0

Step 7. Edge Finish
For laminate top/thermoplastic edge (L)

76	light brown walnut	+\$0
8Q	folkstone grey	+\$0
91	white	+\$0
98	studio white	+\$0
CL	cool grey neutral	+\$0
LA	light ash	+\$0
LBA	clear on ash	+\$0
LBR	phantom ecru	+\$0
LBS	phantom cocoa	+\$0
LBU	medium matte walnut	+\$0
LBV	warm grey teak	+\$0
LBB	oak on ash	+\$0
LBC	walnut on ash	+\$0
LBD	dark brown walnut	+\$0
LBE	medium red walnut	+\$0
LBF	neutral twill	+\$0
LBG	sarum twill	+\$0
LBH	earthen twill	+\$0
LBJ	graphite twill	+\$0
LBK	pewter mesh	+\$0
LBL	steel mesh	+\$0
LBM	crisp linen	+\$0
LBN	classic linen	+\$0
LBP	casual linen	+\$0
LBQ	white twill	+\$0
WL	sandstone	+\$0
WN	warm grey neutral	+\$0
HF	inner tone light	+\$0
HM	natural maple	+\$0
HP	light anigre	+\$0
HT	inner tone A	+\$0
HX	aged cherry	+\$0
HY	walnut on cherry	+\$0
LU	soft white	+\$0

Round Table *continued*

Everywhere™ Standard-Height Tables

Step 8. Leg/Base Finish		
8Q	folkstone grey	+\$0
91	white	+\$0
98	studio white <input type="checkbox"/> A	+\$0
BU	black umber	+\$0
CL	cool grey neutral	+\$0
G2	graphite satin	+\$0
HF	inner tone light	+\$0
LU	soft white	+\$0
MT	medium tone	+\$0
SG	slate grey	+\$0
WL	sandstone	+\$0
WN	warm grey neutral	+\$0
CN	metallic champagne	+\$0
EH	metallic bronze	+\$0
MS	metallic silver	+\$0
CD	polished aluminum	+\$110
Step 9. Casters/Glides		
20	casters	+\$0
57	glides	+\$0

Oval Table

DT1DE.
DT1DS.
DT1DT.

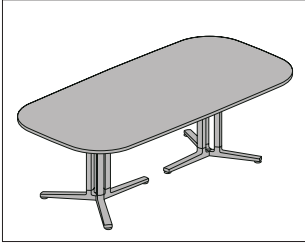

Product Information

Description

This oval table comes in multiple edge styles and has a laminate top with thermoplastic edge, veneer top and edge, or painted top and edge. It has multiple leg/base options, and is available with casters or glides. The caster option has 2 locking and 2 non-locking casters. Glides have 1/2" leveling range. Shipped knocked down.

Notes

When specifying grommets (253, 254, 255), cutouts will be located in the center of table.

Cutouts available for all Connect™ power and data accessories (see Thrive® Portfolio). Cutouts will be located in the center, laterally and front to back.

For additional details on available edge options see Appendices.

For additional size, edge, and finish options, see Vary Easy Program in Appendices.

Dimensions

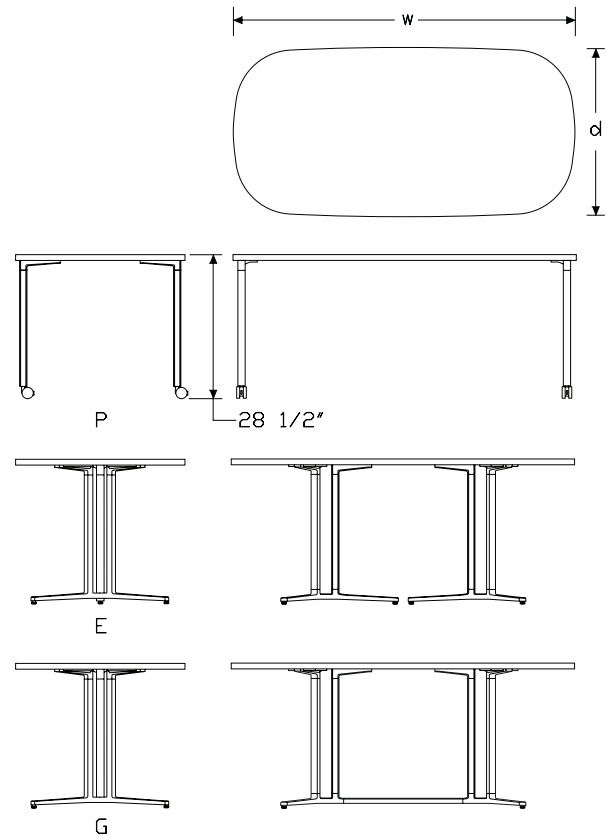

Everywhere™ Standard-Height Tables

Oval Table *continued*

Specification Information	
Step 1.	
DT1D	
Step 2. Edge	
S.	squared-edge
T.	thin-edge
E.	eased-edge
Step 3. Depth	
30	30" deep
36	36" deep
42	42" deep
Step 4. Width	
<i>For 30" deep (30)</i>	
48	48" wide
60	60" wide
<i>For 36" deep (36)</i>	
60	60" wide
72	72" wide
<i>For 42" deep (42)</i>	
72	72" wide
84	84" wide
Step 5. Surface Material	
<i>For squared-edge (S.)</i>	
L	lamine top/thermoplastic edge
W	veneer top/veneer edge A
P	painted Formcoat® top/edge
<i>For thin-edge (T.)</i>	
W	veneer top/veneer edge A
P	painted Formcoat® top/edge
<i>For eased-edge (E.)</i>	
P	painted Formcoat® top/edge
Step 6. Leg/Base Type	
<i>For 48" wide (48) or 60" wide (60)</i>	
P	post leg
G	double 3-column base, spanner

<i>For 72" wide (72) or 84" wide (84)</i>							
P	post leg						
E	double 3-column base						
G	double 3-column base, spanner						
Prices for Steps 1-6.							
		LP	LE	LG	WP	WE	WG
DT1DS. 30	48	\$929	—	1530	1377	—	2314
	60	\$1003	—	1654	1493	—	2503
	36 60	\$1113	—	1836	1666	—	2787
	72	\$1280	2175	2112	1924	3312	3215
	42 72	\$1371	2326	2259	2064	3550	3445
	84	\$1410	2392	2322	2123	3650	3544
					PP	PE	PG
DT1DS. 30	48				\$1068	—	1762
	60				\$1153	—	1902
	36 60				\$1280	—	2112
	72				\$1473	2502	2429
	42 72				\$1576	2676	2598
	84				\$1620	2751	2671
		LP	LE	LG	WP	WE	WG
DT1DT. 30	48	—	—	—	\$1654	—	2775
	60	—	—	—	\$1791	—	3002
	36 60	—	—	—	\$2000	—	3344
	72	—	—	—	\$2310	3975	3858
	42 72	—	—	—	\$2477	4260	4133
	84	—	—	—	\$2547	4381	4252
					PP	PE	PG
DT1DT. 30	48				\$1138	—	1875
	60				\$1229	—	2024
	36 60				\$1364	—	2250
	72				\$1568	2664	2586
	42 72				\$1678	2849	2767
	84				\$1727	2930	2844
					PP	PE	PG
DT1DE. 30	48				\$1138	—	1875
	60				\$1229	—	2024
	36 60				\$1364	—	2250
	72				\$1568	2664	2586
	42 72				\$1678	2849	2767
	84				\$1727	2930	2844

Step 7.

Top Finish

For laminate top/thermoplastic edge (L)

1X	vanilla	+\$0
28	canyon	+\$0
29	misted	+\$0
2X	wheat	+\$0
38	twilight	+\$0
39	desert	+\$0
3X	celery	+\$0
4X	coriander	+\$0
5X	chamomile	+\$0
6X	cinnamon	+\$0
76	light brown walnut	+\$0
7X	cardamom	+\$0
8Q	folkstone grey	+\$0
8X	kale	+\$0
91	white	+\$0
98	studio white	+\$0
CL	cool grey neutral	+\$0
HF	inner tone light	+\$0
HM	natural maple	+\$0
HP	light anigre	+\$0
HT	inner tone A	+\$0
HX	aged cherry	+\$0
HY	walnut on cherry	+\$0
J4	frosted light grey	+\$0
LA	light ash	+\$0
LBA	clear on ash	+\$0
LBB	oak on ash	+\$0
LBC	walnut on ash	+\$0
LBD	dark brown walnut	+\$0
LBE	medium red walnut	+\$0
LBF	neutral twill	+\$0
LBG	sarum twill	+\$0
LBH	earthen twill	+\$0
LBJ	graphite twill	+\$0
LBK	pewter mesh	+\$0
LBL	steel mesh	+\$0
LBM	crisp linen	+\$0
LBN	classic linen	+\$0
LBP	casual linen	+\$0
LBQ	white twill	+\$0
LBR	phantom ecru	+\$0
LBS	phantom cocoa	+\$0
LBU	medium matte walnut	+\$0

LBV	warm grey teak	+\$0
LG	light grey (discontinuing) A	+\$0
LM	mahogany	+\$0
LT	light tone A	+\$0
LU	soft white	+\$0
MT	medium tone	+\$0
OG	honey maple A	+\$0
WL	sandstone	+\$0
WN	warm grey neutral	+\$0
X1	chalk white A	+\$0

Top/Edge Finish: Wood Veneer

For veneer top/veneer edge (W)

2U	light brown walnut A	+\$50
40	dark brown walnut A	+\$50
ED	aged cherry A	+\$50
EK	medium red walnut A	+\$50
EW	medium matte walnut A	+\$50
ET	clear on ash A	+\$50
EU	oak on ash A	+\$50
EV	walnut on ash A	+\$50
UL	natural maple A	+\$50
UX	walnut on cherry A	+\$50

Top/Edge Finish: Opaque Formcoat®

For painted Formcoat® top/edge (P)

8Q	folkstone grey	+\$0
91	white	+\$0
CL	cool grey neutral	+\$0
LU	soft white	+\$0
WL	sandstone	+\$0
WN	warm grey neutral	+\$0

Step 8. Edge Finish

For laminate top/thermoplastic edge (L)

28	canyon	+\$0
29	misted	+\$0
38	twilight	+\$0
39	desert	+\$0
76	light brown walnut	+\$0
8Q	folkstone grey	+\$0
8Z	neutral grey	+\$0
91	white	+\$0
98	studio white	+\$0
9V	tapestry beige	+\$0
BU	black umber A	+\$0
CL	cool grey neutral	+\$0

Oval Table *continued*

Everywhere™ Standard-Height Tables

CM	cinnamon	+\$0
CO	chamomile	+\$0
G2	graphite satin	+\$0
HF	inner tone light	+\$0
HM	natural maple	+\$0
HP	light anigre	+\$0
HT	inner tone A	+\$0
HX	aged cherry	+\$0
HY	walnut on cherry	+\$0
JB	millwork cherry	+\$0
LA	light ash	+\$0
LBA	clear on ash	+\$0
LBB	oak on ash	+\$0
LBC	walnut on ash	+\$0
LBD	dark brown walnut	+\$0
LBE	medium red walnut	+\$0
LBF	neutral twill	+\$0
LBG	sarum twill	+\$0
LBH	earthen twill	+\$0
LBJ	graphite twill	+\$0
LBK	pewter mesh	+\$0
LBL	steel mesh	+\$0
LBM	crisp linen	+\$0
LBN	classic linen	+\$0
LBP	casual linen	+\$0
LBQ	white twill	+\$0
LBR	phantom ecru	+\$0
LBS	phantom cocoa	+\$0
LBU	medium matte walnut	+\$0
LBV	warm grey teak	+\$0
LG	light grey (discontinuing) A	+\$0
LM	mahogany	+\$0
LT	light tone A	+\$0
LU	soft white	+\$0
MT	medium tone	+\$0
N3	cool grey	+\$0
OG	honey maple A	+\$0
SG	slate grey	+\$0
WA	wheat	+\$0
WL	sandstone	+\$0
WN	warm grey neutral	+\$0
X1	chalk white A	+\$0

Step 9. Leg/Base Finish		
8Q	folkstone grey	+\$0
91	white	+\$0
98	studio white A	+\$0
BU	black umber	+\$0
CL	cool grey neutral	+\$0
G2	graphite satin	+\$0
HF	inner tone light	+\$0
LU	soft white	+\$0
MT	medium tone	+\$0
SG	slate grey	+\$0
WL	sandstone	+\$0
WN	warm grey neutral	+\$0
CN	metallic champagne	+\$0
EH	metallic bronze	+\$0
MS	metallic silver	+\$0
CD	polished aluminum	+\$110

Step 10. Casters/Glides		
20	casters	+\$0
57	glides	+\$0

Step 11. Grommets		
NTG	no grommet	+\$0
253	cutout for Y1420. or Y1425. - 3 port	+\$27
254	cutout for Y1420. or Y1425. - 5 port	+\$27
255	cutout for Y1420. or Y1425. - 6 port	+\$27

D-Shaped Table

DT1EE.
DT1ES.
DT1ET.

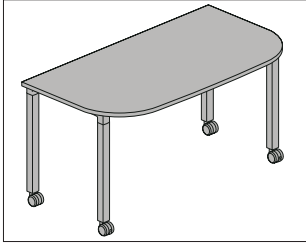

Product Information

Description

This D-shaped table comes in multiple edge styles and has a laminate top with thermoplastic edge, veneer top and edge, or painted top and edge. It has multiple leg options, and is available with casters or glides. The caster option has 2 locking and 2 non-locking casters. Glides have $\frac{1}{2}$ " leveling range. Shipped knocked down.

Height-adjustable legs have a 5" range in 1" increments.

Notes

Thin edge and eased edge tops available only with 30" deep surfaces. T-leg and T-leg with height adjustment cannot be used with 18" deep tops.

Cable grommet options available through Vary Easy Program for round pass through grommet with $2\frac{1}{4}$ " hole clearance. Holes are located 3" from rear edge and 6" from end for the L and R options. Covers not provided with painted surface option.

Cutouts available for all Connect™ power and data accessories (see Thrive® Portfolio). Cutouts will be located in the center, laterally, and approximately 3" from the rear edge of surface.

Reinforcement channels are used under table tops 54" and wider. They will be located along the center line for 18" deep and 24" deep surfaces, and 19" from the front edge for 30" deep surfaces.

For additional details on available edge options see Appendices.

For additional size, edge, and finish options, see Vary Easy Program in Appendices.

UL listed when used with Connect single circuit electrical product (Y137x.) with post leg (P) and T-leg (T) options.

Dimensions

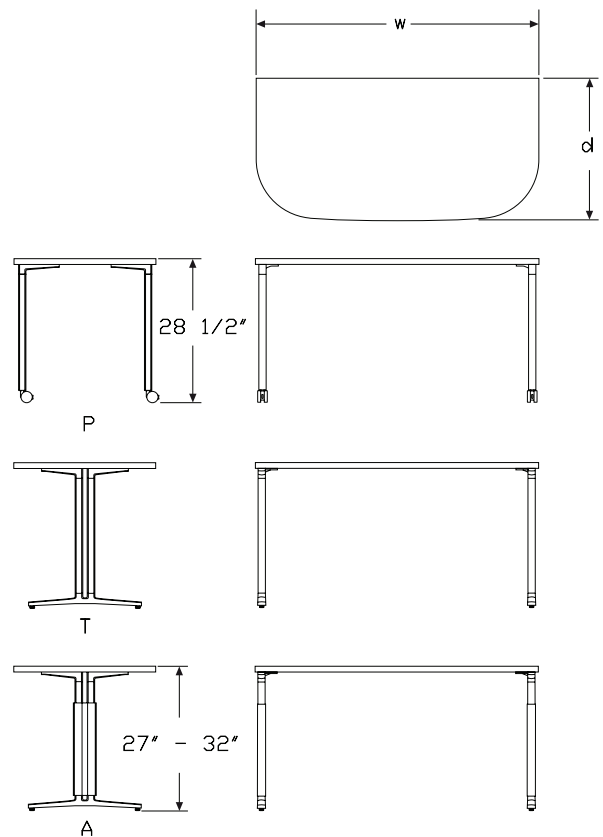

D-Shaped Table *continued*

Specification Information

Step 1.

DT1E

Step 2. Edge

- S.** squared-edge
- T.** thin-edge
- E.** eased-edge

Step 3. Depth/Width

For thin-edge (T.) or eased-edge (E.)

3060 30" deep x 60" wide

For squared-edge (S.)

1836 18" deep x 36" wide

2448 24" deep x 48" wide

3060 30" deep x 60" wide

Step 4. Surface Material

For squared-edge (S.)

- L** laminate top/thermoplastic edge
- W** veneer top/veneer edge **A**
- P** painted Formcoat® top/edge

For thin-edge (T.)

- W** veneer top/veneer edge **A**
- P** painted Formcoat® top/edge

For eased-edge (E.)

- P** painted Formcoat® top/edge

Step 5. Leg Type

For 18" deep x 36" wide (1836)

- P** post leg

For 30" deep x 60" wide (3060) or 24" deep x 48" wide (2448)

- P** post leg
- T** T-leg
- A** T-leg with height adjustment

Prices for Steps 1-5.

	P	T	A
DT1ES. 1836 L	\$725	—	—
W	\$844	—	—
P	\$834	—	—
2448 L	\$869	1364	1652
W	\$1025	1536	1951
P	\$1000	1568	1899
3060 L	\$999	1567	1898
W	\$1186	1784	2266
P	\$1149	1802	2181
	P	T	A
DT1ET. 3060 W	\$1422	2142	2720
P	\$1222	1919	2324

	P	T	A
DT1EE. 3060 P	\$1222	1919	2324

Step 6.

Top Finish

For laminate top/thermoplastic edge (L)

28	canyon	+\$0
29	misted	+\$0
38	twilight	+\$0
39	desert	+\$0
76	light brown walnut	+\$0
91	white	+\$0
98	studio white	+\$0
1X	vanilla	+\$0
2X	wheat	+\$0
3X	celery	+\$0
4X	coriander	+\$0
5X	chamomile	+\$0
6X	cinnamon	+\$0
7X	cardamom	+\$0
8X	kale	+\$0
8Q	folkstone grey	+\$0
CL	cool grey neutral	+\$0
HF	inner tone light	+\$0
HM	natural maple	+\$0
HP	light anigre	+\$0
HT	inner tone	+\$0
HX	aged cherry	+\$0
HY	walnut on cherry	+\$0
J4	frosted light grey	+\$0

D-Shaped Table *continued*

LA	light ash	+\$0
LBA	clear on ash	+\$0
LBR	phantom ecru	+\$0
LBS	phantom cocoa	+\$0
LBU	medium matte walnut	+\$0
LBV	warm grey teak	+\$0
LBB	oak on ash	+\$0
LBC	walnut on ash	+\$0
LBD	dark brown walnut	+\$0
LBE	medium red walnut	+\$0
LBF	neutral twill	+\$0
LBG	sarum twill	+\$0
LBH	earthen twill	+\$0
LBJ	graphite twill	+\$0
LBK	pewter mesh	+\$0
LBL	steel mesh	+\$0
LBM	crisp linen	+\$0
LBN	classic linen	+\$0
LBP	casual linen	+\$0
LBQ	white twill	+\$0
LG	light grey (discontinuing)	+\$0
LM	mahogany	+\$0
LT	light tone	+\$0
LU	soft white	+\$0
MT	medium tone	+\$0
OG	honey maple	+\$0
WL	sandstone	+\$0
WN	warm grey neutral	+\$0
X1	chalk white	+\$0

Top/Edge Finish: Wood Veneer

For veneer top/veneer edge (W)

2U	light brown walnut <input type="checkbox"/>	+\$50
40	dark brown walnut <input type="checkbox"/>	+\$50
ED	aged cherry <input type="checkbox"/>	+\$50
EK	medium red walnut <input type="checkbox"/>	+\$50
EW	medium matte walnut <input type="checkbox"/>	+\$50
ET	clear on ash <input type="checkbox"/>	+\$50
EU	oak on ash <input type="checkbox"/>	+\$50
EV	walnut on ash <input type="checkbox"/>	+\$50
UL	natural maple <input type="checkbox"/>	+\$50
UX	walnut on cherry <input type="checkbox"/>	+\$50

Top/Edge Finish: Opaque Formcoat®

For painted Formcoat® top/edge (P)

8Q	folkstone grey	+\$0
91	white	+\$0
CL	cool grey neutral	+\$0
LU	soft white	+\$0
WL	sandstone	+\$0
WN	warm grey neutral	+\$0

Step 7. Edge Finish

For laminate top/thermoplastic edge (L)

76	light brown walnut	+\$0
8Q	folkstone grey	+\$0
91	white	+\$0
98	studio white	+\$0
CL	cool grey neutral	+\$0
LA	light ash	+\$0
LBA	clear on ash	+\$0
LBR	phantom ecru	+\$0
LBS	phantom cocoa	+\$0
LBU	medium matte walnut	+\$0
LBV	warm grey teak	+\$0
LBB	oak on ash	+\$0
LBC	walnut on ash	+\$0
LBD	dark brown walnut	+\$0
LBE	medium red walnut	+\$0
LBF	neutral twill	+\$0
LBG	sarum twill	+\$0
LBH	earthen twill	+\$0
LBJ	graphite twill	+\$0
LBK	pewter mesh	+\$0
LBL	steel mesh	+\$0
LBM	crisp linen	+\$0
LBN	classic linen	+\$0
LBP	casual linen	+\$0
LBQ	white twill	+\$0
WL	sandstone	+\$0
WN	warm grey neutral	+\$0
HF	inner tone light	+\$0
HM	natural maple	+\$0
HP	light anigre	+\$0
HT	inner tone	+\$0
HX	aged cherry	+\$0
HY	walnut on cherry	+\$0
LU	soft white	+\$0

D-Shaped Table *continued*

Step 8. Leg Finish		
8Q	folkstone grey	+\$0
91	white	+\$0
98	studio white <input type="checkbox"/> A	+\$0
BU	black umber	+\$0
CL	cool grey neutral	+\$0
G2	graphite satin	+\$0
HF	inner tone light	+\$0
LU	soft white	+\$0
MT	medium tone	+\$0
SG	slate grey	+\$0
WL	sandstone	+\$0
WN	warm grey neutral	+\$0
CN	metallic champagne	+\$0
EH	metallic bronze	+\$0
MS	metallic silver	+\$0
CD	polished aluminum	+\$110

Step 9. Casters/Glides		
20	casters	+\$0
57	glides	+\$0

Soft Rectangle - Meeting Table

DT1FE.
DT1FS.
DT1FT.

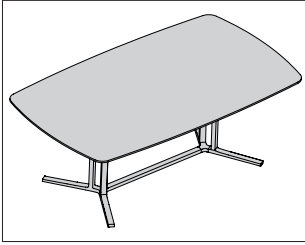

Product Information

Description

This rectangular table comes in multiple edge styles and has a laminate top with thermoplastic edge, veneer top and edge, or painted top and edge. It has multiple leg/base options, and is available with casters or glides. The caster option has 2 locking and 2 non-locking casters. Glides have 1/2" leveling range. Shipped knocked down.

Notes

When specifying grommets (253, 254, 255), cutouts will be located in the center of table.

Cutouts available for all Connect™ power and data accessories (see Thrive® Portfolio). Cutouts will be located in the center, laterally and front to back.

For additional details on available edge options see Appendices.

For additional size, edge, and finish options, see Vary Easy Program in Appendices.

Dimensions

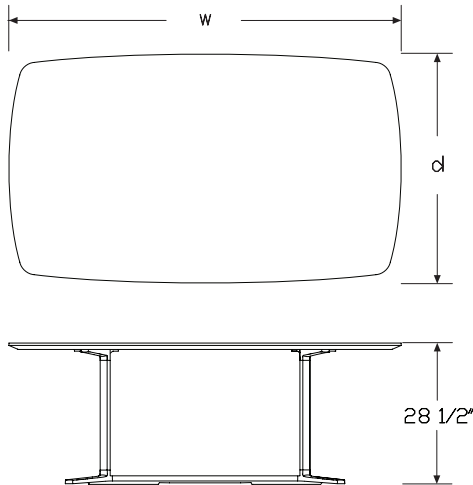

Specification Information

Step 1.

DT1F

Step 2. Edge

- S.** squared-edge
- T.** thin-edge
- E.** eased-edge

Step 3. Depth

- 30** 30" deep
- 36** 36" deep
- 42** 42" deep

Step 4. Width

For 30" deep (30)

- 48** 48" wide
- 60** 60" wide

For 36" deep (36)

- 60** 60" wide
- 72** 72" wide

For 42" deep (42)

- 72** 72" wide
- 84** 84" wide

Step 5. Surface Material

For squared-edge (S.)

- L** laminate top/thermoplastic edge
- W** veneer top/veneer edge **A**
- P** painted Formcoat® top/edge

For thin-edge (T.)

- W** veneer top/veneer edge **A**
- P** painted Formcoat® top/edge

For eased-edge (E.)

- P** painted Formcoat® top/edge

Soft Rectangle - Meeting Table

continued

Everywhere™ Standard-Height Tables

Step 6. Leg/Base Type

For 48" wide (48) or 60" wide (60)

P	post leg
G	double 3-column base, spanner
T	T-leg
A	T-leg with height adjustment

For 72" wide (72) or 84" wide (84)

P	post leg
E	double 3-column base
G	double 3-column base, spanner

Prices for Steps 1-6.

	LP	LE	LG	LT	LA	WP
DT1FS. 30 48	\$1068	—	1761	1506	1879	1586
60	\$1153	—	1901	1646	2166	1715
36 60	\$1280	—	2112	1858	1898	1915
72	\$1473	2502	2428	—	—	2213
42 84	\$1620	2749	2669	—	—	2440
72	\$1576	2676	2598	—	—	2372

	WE	WG	WT	WA	PP	PE
DT1FS. 30 48	—	\$2659	2405	2396	1226	—
60	—	\$2878	2623	2765	1326	—
36 60	—	\$3205	2951	2480	1471	—
72	\$3810	3698	—	—	1693	2876
42 84	\$4198	4074	—	—	1863	3161
72	\$4080	3961	—	—	1813	3076

	PG	PT	PA
DT1FS. 30 48	\$2024	1732	2163
60	\$2184	1895	2491
36 60	\$2428	2135	2181
72	\$2792	—	—
42 84	\$3069	—	—
72	\$2988	—	—

	LP	LE	LG	LT	LA	WP
DT1FT. 30 48	—	—	—	—	—	\$1901
60	—	—	—	—	—	\$2060
36 60	—	—	—	—	—	\$2298
72	—	—	—	—	—	\$2655
42 84	—	—	—	—	—	\$2929
72	—	—	—	—	—	\$2847

	WE	WG	WT	WA	PP	PE
DT1FT. 30 48	—	\$3190	2885	2876	1306	—
60	—	\$3452	3147	3319	1412	—
36 60	—	\$3845	3540	2977	1567	—
72	\$4571	4435	—	—	1804	3063
42 84	\$5036	4888	—	—	1984	3370
72	\$4896	4752	—	—	1930	3275

	PG	PT	PA
DT1FT. 30 48	\$2156	2766	3453
60	\$2328	3024	3976
36 60	\$2585	3410	3485
72	\$2974	—	—
42 84	\$3270	—	—
72	\$3182	—	—

	WE	WG	WT	WA	PP	PE
DT1FE. 30 48	—	—	—	—	\$1306	—
60	—	—	—	—	\$1412	—
36 60	—	—	—	—	\$1567	—
72	—	—	—	—	\$1804	3063
42 84	—	—	—	—	\$1984	3370
72	—	—	—	—	\$1930	3275

	PG	PT	PA
DT1FE. 30 48	\$2156	1845	2304
60	\$2328	2017	2651
36 60	\$2585	2274	2324
72	\$2974	—	—
42 84	\$3270	—	—
72	\$3182	—	—

Step 7.

Top Finish

For laminate top/thermoplastic edge (L)

28	canyon	+\$0
29	misted	+\$0
38	twilight	+\$0
39	desert	+\$0
76	light brown walnut	+\$0
91	white	+\$0
98	studio white	+\$0
1X	vanilla	+\$0
2X	wheat	+\$0
3X	celery	+\$0
4X	coriander	+\$0

Soft Rectangle - Meeting Table

continued

5X	chamomile	+\$0
6X	cinnamon	+\$0
7X	cardamom	+\$0
8X	kale	+\$0
8Q	folkstone grey	+\$0
CL	cool grey neutral	+\$0
HF	inner tone light	+\$0
HM	natural maple	+\$0
HP	light anigre	+\$0
HT	inner tone	+\$0
HX	aged cherry	+\$0
HY	walnut on cherry	+\$0
J4	frosted light grey	+\$0
LA	light ash	+\$0
LBA	clear on ash	+\$0
LBR	phantom ecru	+\$0
LBS	phantom cocoa	+\$0
LBU	medium matte walnut	+\$0
LBV	warm grey teak	+\$0
LBB	oak on ash	+\$0
LBC	walnut on ash	+\$0
LBD	dark brown walnut	+\$0
LBE	medium red walnut	+\$0
LBF	neutral twill	+\$0
LBG	sarum twill	+\$0
LBH	earthen twill	+\$0
LBJ	graphite twill	+\$0
LBK	pewter mesh	+\$0
LBL	steel mesh	+\$0
LBM	crisp linen	+\$0
LBN	classic linen	+\$0
LBP	casual linen	+\$0
LBQ	white twill	+\$0
LG	light grey (discontinuing)	+\$0
LM	mahogany	+\$0
LT	light tone	+\$0
LU	soft white	+\$0
MT	medium tone	+\$0
OG	honey maple	+\$0
WL	sandstone	+\$0
WN	warm grey neutral	+\$0
X1	chalk white	+\$0

Top/Edge Finish		
<i>For veneer top/veneer edge (W)</i>		
2U	light brown walnut <input type="checkbox"/> A	+\$85
40	dark brown walnut <input type="checkbox"/> A	+\$85
ED	aged cherry <input type="checkbox"/> A	+\$85
EK	medium red walnut <input type="checkbox"/> A	+\$85
EW	medium matte walnut <input type="checkbox"/> A	+\$85
ET	clear on ash <input type="checkbox"/> A	+\$85
EU	oak on ash <input type="checkbox"/> A	+\$85
EV	walnut on ash <input type="checkbox"/> A	+\$85
UL	natural maple <input type="checkbox"/> A	+\$85
UX	walnut on cherry <input type="checkbox"/> A	+\$85

Top/Edge Finish: Opaque Formcoat®		
<i>For painted Formcoat® top/edge (P)</i>		
8Q	folkstone grey	+\$0
91	white	+\$0
CL	cool grey neutral	+\$0
LU	soft white	+\$0
WL	sandstone	+\$0
WN	warm grey neutral	+\$0

Step 8. Edge Finish		
<i>For laminate top/thermoplastic edge (L)</i>		
76	light brown walnut	+\$0
8Q	folkstone grey	+\$0
91	white	+\$0
98	studio white	+\$0
CL	cool grey neutral	+\$0
LA	light ash	+\$0
LBA	clear on ash	+\$0
LBR	phantom ecru	+\$0
LBS	phantom cocoa	+\$0
LBU	medium matte walnut	+\$0
LBV	warm grey teak	+\$0
LBB	oak on ash	+\$0
LBC	walnut on ash	+\$0
LBD	dark brown walnut	+\$0
LBE	medium red walnut	+\$0
LBF	neutral twill	+\$0
LBG	sarum twill	+\$0
LBH	earthen twill	+\$0
LBJ	graphite twill	+\$0
LBK	pewter mesh	+\$0
LBL	steel mesh	+\$0
LBM	crisp linen	+\$0
LBN	classic linen	+\$0

Everywhere™ Standard-Height Tables

Soft Rectangle - Meeting Table

continued

Everywhere™ Standard-Height Tables

LBP	casual linen	+\$0
LBQ	white twill	+\$0
WL	sandstone	+\$0
WN	warm grey neutral	+\$0
HF	inner tone light	+\$0
HM	natural maple	+\$0
HP	light anigre	+\$0
HT	inner tone	+\$0
HX	aged cherry	+\$0
HY	walnut on cherry	+\$0
LU	soft white	+\$0
X1	chalk white	+\$0

Step 9. Leg/Base Finish

8Q	folkstone grey	+\$0
91	white	+\$0
98	studio white <input type="checkbox"/> A	+\$0
BU	black umber	+\$0
CL	cool grey neutral	+\$0
G2	graphite satin	+\$0
HF	inner tone light	+\$0
LU	soft white	+\$0
MT	medium tone	+\$0
SG	slate grey	+\$0
WL	sandstone	+\$0
WN	warm grey neutral	+\$0
CN	metallic champagne	+\$0
EH	metallic bronze	+\$0
MS	metallic silver	+\$0
CD	polished aluminum	+\$110

Step 10. Casters/Glides

20	casters	+\$0
57	glides	+\$0

Step 11. Grommets

NTG	no grommet	+\$0
253	cutout for Y1420. or Y1425. - 3 port	+\$27
254	cutout for Y1420. or Y1425. - 5 port	+\$27
255	cutout for Y1420. or Y1425. - 6 port	+\$27

Video Oval - Meeting Table

DT1GE.
DT1GS.
DT1GT.

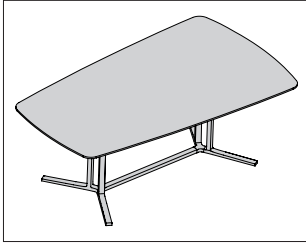

Product Information

Description

This oval table comes in multiple edge styles and has a laminate top with thermoplastic edge, veneer top and edge, or painted top and edge. It has multiple leg/base options, and is available with casters or glides. The caster option has 2 locking and 2 non-locking casters. Glides have 1/2" leveling range. Shipped knocked down.

Notes

When specifying grommets (253, 254, 255), cutouts will be located in the center of table.

Cutouts available for all Connect™ power and data accessories (see Thrive® Portfolio). Cutouts will be located in the center, laterally and front to back.

For optimum viewing, video camera should be placed 42" from large end of table.

For additional details on available edge options see Appendices.

For additional size, edge, and finish options, see Vary Easy Program in Appendices.

Dimensions

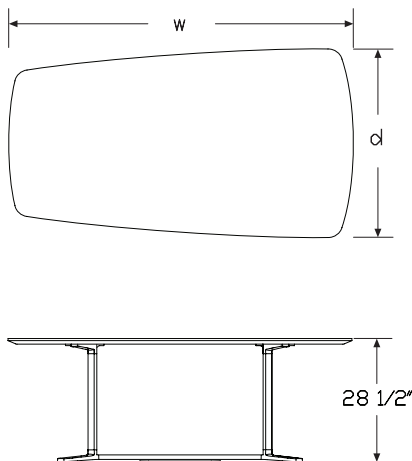

Specification Information

Step 1.

DT1G

Step 2. Edge

- S.** squared-edge
- T.** thin-edge
- E.** eased-edge

Step 3. Depth

42 42" deep

Step 4. Width

72 72" wide
84 84" wide

Step 5. Surface Material

For squared-edge (S.)

- L** laminate top/thermoplastic edge
- W** veneer top/veneer edge **A**
- P** painted Formcoat® top/edge

For thin-edge (T.)

- W** veneer top/veneer edge **A**
- P** painted Formcoat® top/edge

For eased-edge (E.)

- P** painted Formcoat® top/edge

Step 6. Leg/Base Type

- E** double 3-column base
- G** double 3-column base, spanner

Prices for Steps 1-6.

	LE	LG	WE	WG	PE	PG
DT1GS. 42 72	\$2676	2598	4080	3961	3076	2988
84	\$2749	2669	4198	4074	3161	3069
DT1GT. 42 72	—	—	\$4896	4752	3768	3660
84	—	—	\$5036	4888	3872	3759
DT1GE. 42 72	—	—	—	—	\$3275	3182
84	—	—	—	—	\$3370	3270

Step 7.

Top Finish

For laminate top/thermoplastic edge (L)

28	canyon	+\$0
29	misted	+\$0
38	twilight	+\$0
39	desert	+\$0
76	light brown walnut	+\$0
91	white	+\$0
98	studio white	+\$0
1X	vanilla	+\$0
2X	wheat	+\$0
3X	celery	+\$0
4X	coriander	+\$0
5X	chamomile	+\$0
6X	cinnamon	+\$0
7X	cardamom	+\$0
8X	kale	+\$0
8Q	folkstone grey	+\$0
CL	cool grey neutral	+\$0
HF	inner tone light	+\$0
HM	natural maple	+\$0
HP	light anigre	+\$0
HT	inner tone	+\$0
HX	aged cherry	+\$0
HY	walnut on cherry	+\$0
J4	frosted light grey	+\$0
LA	light ash	+\$0
LBA	clear on ash	+\$0
LBR	phantom ecru	+\$0
LBS	phantom cocoa	+\$0
LBU	medium matte walnut	+\$0
LBV	warm grey teak	+\$0
LBB	oak on ash	+\$0
LBC	walnut on ash	+\$0
LBD	dark brown walnut	+\$0
LBE	medium red walnut	+\$0
LBF	neutral twill	+\$0
LBG	sarum twill	+\$0
LBH	earthen twill	+\$0
LBJ	graphite twill	+\$0
LBK	pewter mesh	+\$0
LBL	steel mesh	+\$0
LBM	crisp linen	+\$0
LBN	classic linen	+\$0
LBP	casual linen	+\$0

LBQ	white twill	+\$0
LG	light grey (discontinuing)	+\$0
LM	mahogany	+\$0
LT	light tone	+\$0
LU	soft white	+\$0
MT	medium tone	+\$0
OG	honey maple	+\$0
WL	sandstone	+\$0
WN	warm grey neutral	+\$0
X1	chalk white	+\$0

Top/Edge Finish

For veneer top/veneer edge (W)

2U	light brown walnut <input type="checkbox"/> A	+\$85
40	dark brown walnut <input type="checkbox"/> A	+\$85
ED	aged cherry <input type="checkbox"/> A	+\$85
EK	medium red walnut <input type="checkbox"/> A	+\$85
EW	medium matte walnut <input type="checkbox"/> A	+\$85
ET	clear on ash <input type="checkbox"/> A	+\$85
EU	oak on ash <input type="checkbox"/> A	+\$85
EV	walnut on ash <input type="checkbox"/> A	+\$85
UL	natural maple <input type="checkbox"/> A	+\$85
UX	walnut on cherry <input type="checkbox"/> A	+\$85

Top/Edge Finish: Opaque Formcoat®

For painted Formcoat® top/edge (P)

8Q	folkstone grey	+\$0
91	white	+\$0
CL	cool grey neutral	+\$0
LU	soft white	+\$0
WL	sandstone	+\$0
WN	warm grey neutral	+\$0

Step 8. Edge Finish

For laminate top/thermoplastic edge (L)

76	light brown walnut	+\$0
8Q	folkstone grey	+\$0
91	white	+\$0
98	studio white	+\$0
CL	cool grey neutral	+\$0
LA	light ash	+\$0
LBA	clear on ash	+\$0
LBR	phantom ecru	+\$0
LBS	phantom cocoa	+\$0
LBU	medium matte walnut	+\$0
LBV	warm grey teak	+\$0
LBB	oak on ash	+\$0

Video Oval - Meeting Table *continued*

LBC	walnut on ash	+\$0
LBD	dark brown walnut	+\$0
LBE	medium red walnut	+\$0
LBF	neutral twill	+\$0
LBG	sarum twill	+\$0
LBH	earthen twill	+\$0
LBJ	graphite twill	+\$0
LBK	pewter mesh	+\$0
LBL	steel mesh	+\$0
LBM	crisp linen	+\$0
LBN	classic linen	+\$0
LBP	casual linen	+\$0
LBQ	white twill	+\$0
WL	sandstone	+\$0
WN	warm grey neutral	+\$0
HF	inner tone light	+\$0
HM	natural maple	+\$0
HP	light anigre	+\$0
HT	inner tone	+\$0
HX	aged cherry	+\$0
HY	walnut on cherry	+\$0
LU	soft white	+\$0

Step 9. Leg/Base Finish

8Q	folkstone grey	+\$0
91	white	+\$0
98	studio white A	+\$0
BU	black umber	+\$0
CL	cool grey neutral	+\$0
G2	graphite satin	+\$0
HF	inner tone light	+\$0
LU	soft white	+\$0
MT	medium tone	+\$0
SG	slate grey	+\$0
WL	sandstone	+\$0
WN	warm grey neutral	+\$0
CN	metallic champagne	+\$0
EH	metallic bronze	+\$0
MS	metallic silver	+\$0
CD	polished aluminum	+\$110

Step 10. Casters/Glides

20	casters	+\$0
57	glides	+\$0

Step 11. Grommets

NTG	no grommet	+\$0
253	cutout for Y1420. or Y1425. - 3 port	+\$27
254	cutout for Y1420. or Y1425. - 5 port	+\$27
255	cutout for Y1420. or Y1425. - 6 port	+\$27

Concave Rectangle

DT1HE.
DT1HS.
DT1HT.

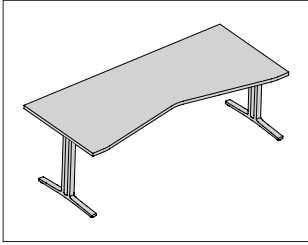

Product Information

Description

This rectangular table comes in multiple edge styles and has a laminate top with thermoplastic edge, veneer top and edge, or painted top and edge. It has multiple leg options, and is available with casters or glides. The caster option has 2 locking and 2 non-locking casters. Glides have 1/2" leveling range. Shipped knocked down. Height-adjustable legs have a 5" range in 1" increments.

Notes

When specifying grommets (253, 254, 255), cutouts will be located in the center of table.

Cutouts available for all Connect™ power and data accessories (see Thrive® Portfolio). Cutouts will be located in the center, laterally, and approximately 3" from the rear edge of surface.

Reinforcement channels are used under table tops 54" and wider. They will be located along the center line for 18" deep and 24" deep surfaces, and 19" from the front edge for 30" deep surfaces.

For additional details on available edge options see Appendices.

For additional size, edge, finish, and cable management options, see Vary Easy Program in Appendices.

UL listed when used with Connect single circuit electrical product (Y137x.) with post leg (P), T-leg (T) and C-leg (C) options.

Dimensions

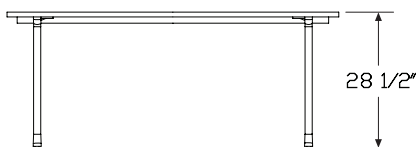
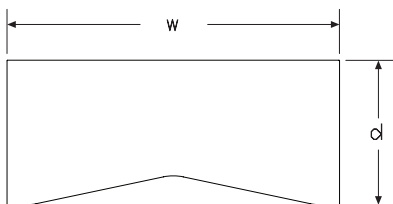

Specification Information

Step 1.

DT1H

Step 2. Edge

- S.** squared-edge
- T.** thin-edge
- E.** eased-edge

Step 3. Depth

- 30** 30" deep
- 36** 36" deep

Step 4. Width

- 60** 60" wide
- 66** 66" wide
- 72** 72" wide

Step 5. Surface Material

For squared-edge (S.)

- L** laminate top/thermoplastic edge
- W** veneer top/veneer edge **A**
- P** painted Formcoat® top/edge

For thin-edge (T.)

- W** veneer top/veneer edge **A**
- P** painted Formcoat® top/edge

For eased-edge (E.)

- P** painted Formcoat® top/edge

Step 6. Leg Type

For 30" deep (30)

- P** post leg
- T** T-leg
- A** T-leg with height adjustment
- C** C-leg
- D** D-leg

For 36" deep (36)

- P** post leg
- T** T-leg
- A** T-leg with height adjustment

Concave Rectangle *continued*

Prices for Steps 1-6.						
	LP	LT	LA	LC	LD	WP
DT1HS. 30 60	\$1215	1578	1971	1578	1971	1501
66	\$1302	1692	2113	1692	2113	1616
72	\$1389	1805	2256	1805	2256	1730
36 60	\$1288	1635	1987	—	—	1558
66	\$1356	1724	2174	—	—	1672
72	\$1424	1813	2360	—	—	1785
	WT	WA	WC	WD	PP	PT
DT1HS. 30 60	\$1974	2485	1974	2485	1398	1814
66	\$2122	2671	2122	2671	1497	1945
72	\$2269	2855	2269	2855	1598	2076
36 60	\$2029	2543	—	—	1482	1879
66	\$2178	2727	—	—	1560	1982
72	\$2325	2913	—	—	1638	2083
			PA	PC	PD	
DT1HS. 30 60			\$2266	1814	2266	
66			\$2430	1945	2430	
72			\$2593	2076	2593	
36 60			\$2285	—	—	
66			\$2499	—	—	
72			\$2715	—	—	
	LP	LT	LA	LC	LD	WP
DT1HT. 30 60	—	—	—	—	—	\$1801
66	—	—	—	—	—	\$1937
72	—	—	—	—	—	\$2076
36 60	—	—	—	—	—	\$1869
66	—	—	—	—	—	\$2006
72	—	—	—	—	—	\$2144
	WT	WA	WC	WD	PP	PT
DT1HT. 30 60	\$2367	2984	2367	2984	1488	1932
66	\$2545	3205	2545	3205	1595	2071
72	\$2723	3426	2723	3426	1702	2211
36 60	\$2435	3051	—	—	1576	2003
66	\$2613	3272	—	—	1662	2111
72	\$2791	3494	—	—	1745	2219
			PA	PC	PD	
DT1HT. 30 60			\$2415	1932	2415	
66			\$2587	2071	2587	
72			\$2762	2211	2762	

36 60	\$2434	—	—			
66	\$2661	—	—			
72	\$2890	—	—			
	WT	WA	WC	WD	PP	PT
DT1HE. 30 60	—	—	—	—	\$1488	1932
66	—	—	—	—	\$1595	2071
72	—	—	—	—	\$1702	2211
36 60	—	—	—	—	\$1576	2003
66	—	—	—	—	\$1662	2111
72	—	—	—	—	\$1745	2219
		PA	PC	PD		
DT1HE. 30 60		\$2415	1932	2415		
66		\$2587	2071	2587		
72		\$2762	2211	2762		
36 60		\$2434	—	—		
66		\$2661	—	—		
72		\$2890	—	—		

Step 7.

Top Finish

For laminate top/thermoplastic edge (L)

28	canyon	+\$0
29	misted	+\$0
38	twilight	+\$0
39	desert	+\$0
76	light brown walnut	+\$0
91	white	+\$0
98	studio white	+\$0
1X	vanilla	+\$0
2X	wheat	+\$0
3X	celery	+\$0
4X	coriander	+\$0
5X	chamomile	+\$0
6X	cinnamon	+\$0
7X	cardamom	+\$0
8X	kale	+\$0
8Q	folkstone grey	+\$0
CL	cool grey neutral	+\$0
HF	inner tone light	+\$0
HM	natural maple	+\$0
HP	light anigre	+\$0
HT	inner tone	+\$0
HX	aged cherry	+\$0
HY	walnut on cherry	+\$0

Everywhere™ Standard-Height Tables

Concave Rectangle *continued*

Everywhere™ Standard-Height Tables

J4	frosted light grey	+\$0
LA	light ash	+\$0
LBA	clear on ash	+\$0
LBR	phantom ecru	+\$0
LBS	phantom cocoa	+\$0
LBU	medium matte walnut	+\$0
LBV	warm grey teak	+\$0
LBB	oak on ash	+\$0
LBC	walnut on ash	+\$0
LBD	dark brown walnut	+\$0
LBE	medium red walnut	+\$0
LBF	neutral twill	+\$0
LBG	sarum twill	+\$0
LBH	earthen twill	+\$0
LBJ	graphite twill	+\$0
LBK	pewter mesh	+\$0
LBL	steel mesh	+\$0
LBM	crisp linen	+\$0
LBN	classic linen	+\$0
LBP	casual linen	+\$0
LBQ	white twill	+\$0
LG	light grey (discontinuing)	+\$0
LM	mahogany	+\$0
LT	light tone	+\$0
LU	soft white	+\$0
MT	medium tone	+\$0
OG	honey maple	+\$0
WL	sandstone	+\$0
WN	warm grey neutral	+\$0
X1	chalk white	+\$0

Top/Edge Finish: Wood Veneer
For veneer top/veneer edge (W)

2U	light brown walnut A	+\$85
40	dark brown walnut A	+\$85
ED	aged cherry A	+\$85
EK	medium red walnut A	+\$85
EW	medium matte walnut A	+\$85
ET	clear on ash	+\$85
EU	oak on ash	+\$85
EV	walnut on ash	+\$85
UL	natural maple A	+\$85
UX	walnut on cherry A	+\$85

Top/Edge Finish: Opaque Formcoat®

For painted Formcoat® top/edge (P)

8Q	folkstone grey	+\$0
91	white	+\$0
CL	cool grey neutral	+\$0
LU	soft white	+\$0
WL	sandstone	+\$0
WN	warm grey neutral	+\$0

Step 8. Edge Finish

For laminate top/thermoplastic edge (L)

76	light brown walnut	+\$0
8Q	folkstone grey	+\$0
91	white	+\$0
98	studio white	+\$0
CL	cool grey neutral	+\$0
LA	light ash	+\$0
LBA	clear on ash	+\$0
LBR	phantom ecru	+\$0
LBS	phantom cocoa	+\$0
LBU	medium matte walnut	+\$0
LBV	warm grey teak	+\$0
LBB	oak on ash	+\$0
LBC	walnut on ash	+\$0
LBD	dark brown walnut	+\$0
LBE	medium red walnut	+\$0
LBF	neutral twill	+\$0
LBG	sarum twill	+\$0
LBH	earthen twill	+\$0
LBJ	graphite twill	+\$0
LBK	pewter mesh	+\$0
LBL	steel mesh	+\$0
LBM	crisp linen	+\$0
LBN	classic linen	+\$0
LBP	casual linen	+\$0
LBQ	white twill	+\$0
WL	sandstone	+\$0
WN	warm grey neutral	+\$0
HF	inner tone light	+\$0
HM	natural maple	+\$0
HP	light anigre	+\$0
HT	inner tone	+\$0
HX	aged cherry	+\$0
HY	walnut on cherry	+\$0
LU	soft white	+\$0

Concave Rectangle *continued*

Step 9. Leg Finish		
8Q	folkstone grey	+\$0
91	white	+\$0
98	studio white <input type="checkbox"/> A	+\$0
BU	black umber	+\$0
CL	cool grey neutral	+\$0
G2	graphite satin	+\$0
HF	inner tone light	+\$0
LU	soft white	+\$0
MT	medium tone	+\$0
SG	slate grey	+\$0
WL	sandstone	+\$0
WN	warm grey neutral	+\$0
CN	metallic champagne	+\$0
EH	metallic bronze	+\$0
MS	metallic silver	+\$0
CD	polished aluminum	+\$110

Step 10. Casters/Glides		
20	casters	+\$0
57	glides	+\$0

Step 11. Grommets		
NTG	no grommet	+\$0
253	cutout for Y1420. or Y1425. - 3 port	+\$27
254	cutout for Y1420. or Y1425. - 5 port	+\$27
255	cutout for Y1420. or Y1425. - 6 port	+\$27

Soft Square Table

DT1JE.
DT1JS.
DT1JT.

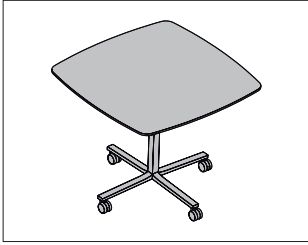

Everywhere™ Standard-Height Tables

Product Information

Description

This square table comes in multiple edge styles and has a laminate top with thermoplastic edge, veneer top and edge, or painted top and edge. It has multiple leg/base options, and is available with casters or glides. The caster option has 2 locking and 2 non-locking casters. Glides have 1/2" leveling range. Shipped knocked down.

Notes

48" tops available only with post leg option for optimum stability.

For additional details on available edge options see Appendices.

For additional size, edge, and finish options, see Vary Easy Program in Appendices.

UL listed when used with Connect™ single circuit electrical product (Y137x.) with post leg (P) option.

Dimensions

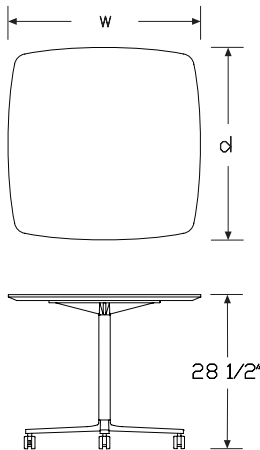

Specification Information

Step 1.

DT1J

Step 2. Edge

- S.** squared-edge
- T.** thin-edge
- E.** eased-edge

Step 3. Depth/Width

- 3030** 30" deep x 30" wide
- 3636** 36" deep x 36" wide
- 4242** 42" deep x 42" wide
- 4848** 48" deep x 48" wide

Step 4. Surface Material

For squared-edge (S.)

- L** laminate top/thermoplastic edge
- W** veneer top/veneer edge A
- P** painted Formcoat® top/edge

For thin-edge (T.)

- W** veneer top/veneer edge A
- P** painted Formcoat® top/edge

For eased-edge (E.)

- P** painted Formcoat® top/edge

Step 5. Leg/Base Type

For 30" deep x 30" wide (3030) or 36" deep x 36" wide (3636)

- P** post leg
- S** single-column base A

For 42" deep x 42" wide (4242)

- P** post leg

For 48" deep x 48" wide (4848)

- P** post leg

Prices for Steps 1-5.

		P	S
DT1JS. 3030	L	\$814	898
	W	\$1030	1143
	P	\$935	1034

Soft Square Table *continued*

3636 L	\$976	1078
W	\$1249	1385
P	\$1122	1239
4242 L	\$1120	—
W	\$1445	—
P	\$1290	—
4848 L	\$1256	—
W	\$1693	—
P	\$1445	—
	P	S
DT1JT. 3030 W	\$1234	1371
P	\$997	1102
3636 W	\$1497	1663
P	\$1196	1321
4242 W	\$1732	—
P	\$1373	—
4848 W	\$2030	—
P	\$1538	—
	P	S
DT1JE. 3030 P	\$997	1102
3636 P	\$1196	1321
4242 P	\$1373	—
4848 P	\$1538	—

Step 6.

Top Finish

For laminate top/thermoplastic edge (L)

28	canyon	+\$0
29	misted	+\$0
38	twilight	+\$0
39	desert	+\$0
76	light brown walnut	+\$0
91	white	+\$0
98	studio white	+\$0
1X	vanilla	+\$0
2X	wheat	+\$0
3X	celery	+\$0
4X	coriander	+\$0
5X	chamomile	+\$0
6X	cinnamon	+\$0
7X	cardamom	+\$0
8X	kale	+\$0
8Q	folkstone grey	+\$0
CL	cool grey neutral	+\$0

HF	inner tone light	+\$0
HM	natural maple	+\$0
HP	light anigre	+\$0
HT	inner tone	+\$0
HX	aged cherry	+\$0
HY	walnut on cherry	+\$0
J4	frosted light grey	+\$0
LA	light ash	+\$0
LBA	clear on ash	+\$0
LBR	phantom ecru	+\$0
LBS	phantom cocoa	+\$0
LBU	medium matte walnut	+\$0
LBV	warm grey teak	+\$0
LBB	oak on ash	+\$0
LBC	walnut on ash	+\$0
LBD	dark brown walnut	+\$0
LBE	medium red walnut	+\$0
LBF	neutral twill	+\$0
LBG	sarum twill	+\$0
LBH	earthen twill	+\$0
LBJ	graphite twill	+\$0
LBK	pewter mesh	+\$0
LBL	steel mesh	+\$0
LBM	crisp linen	+\$0
LBN	classic linen	+\$0
LBP	casual linen	+\$0
LBQ	white twill	+\$0
LG	light grey (discontinuing)	+\$0
LM	mahogany	+\$0
LT	light tone	+\$0
LU	soft white	+\$0
MT	medium tone	+\$0
OG	honey maple	+\$0
WL	sandstone	+\$0
WN	warm grey neutral	+\$0
X1	chalk white	+\$0

Soft Square Table *continued*

Everywhere™ Standard-Height Tables

Top/Edge Finish: Wood Veneer		
<i>For veneer top/veneer edge (W)</i>		
2U	light brown walnut	+\$85
40	dark brown walnut	+\$85
ED	aged cherry	+\$85
EK	medium red walnut	+\$85
EW	medium matte walnut	+\$85
ET	clear on ash	+\$85
EU	oak on ash	+\$85
EV	walnut on ash	+\$85
UL	natural maple	+\$85
UX	walnut on cherry	+\$85

Top/Edge Finish: Opaque Formcoat®		
<i>For painted Formcoat® top/edge (P)</i>		
8Q	folkstone grey	+\$0
91	white	+\$0
CL	cool grey neutral	+\$0
LU	soft white	+\$0
WL	sandstone	+\$0
WN	warm grey neutral	+\$0

Step 7. Edge Finish		
<i>For laminate top/thermoplastic edge (L)</i>		
76	light brown walnut	+\$0
8Q	folkstone grey	+\$0
91	white	+\$0
98	studio white	+\$0
CL	cool grey neutral	+\$0
LA	light ash	+\$0
LBA	clear on ash	+\$0
LBR	phantom ecru	+\$0
LBS	phantom cocoa	+\$0
LBU	medium matte walnut	+\$0
LBV	warm grey teak	+\$0
LBB	oak on ash	+\$0
LBC	walnut on ash	+\$0
LBD	dark brown walnut	+\$0
LBE	medium red walnut	+\$0
LBF	neutral twill	+\$0
LBG	sarum twill	+\$0
LBH	earthen twill	+\$0
LBJ	graphite twill	+\$0
LBK	pewter mesh	+\$0
LBL	steel mesh	+\$0
LBM	crisp linen	+\$0
LBN	classic linen	+\$0

LBP	casual linen	+\$0
LBQ	white twill	+\$0
WL	sandstone	+\$0
WN	warm grey neutral	+\$0
HF	inner tone light	+\$0
HM	natural maple	+\$0
HP	light anigre	+\$0
HT	inner tone	+\$0
HX	aged cherry	+\$0
HY	walnut on cherry	+\$0
LU	soft white	+\$0

Step 8. Leg Finish		
8Q	folkstone grey	+\$0
91	white	+\$0
98	studio white A	+\$0
BU	black umber	+\$0
CL	cool grey neutral	+\$0
G2	graphite satin	+\$0
HF	inner tone light	+\$0
LU	soft white	+\$0
MT	medium tone	+\$0
SG	slate grey	+\$0
WL	sandstone	+\$0
WN	warm grey neutral	+\$0
CN	metallic champagne	+\$0
EH	metallic bronze	+\$0
MS	metallic silver	+\$0
CD	polished aluminum	+\$110

Step 9. Casters/Glides		
20	casters	+\$0
57	glides	+\$0

Tear Drop Table

DT1KE.
DT1KS.
DT1KT.

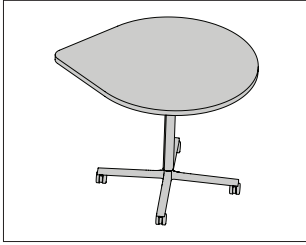

Product Information

Description

This tear drop table comes in multiple edge styles and has a laminate top with thermoplastic edge, veneer top and edge, or painted top and edge. It has multiple leg/base options, and is available with casters or glides. The caster option has 2 locking and 2 non-locking casters. Glides have 1/2" leveling range. Shipped knocked down.

Notes

For additional details on available edge options see Appendices.

For additional size, edge, and finish options, see Vary Easy Program in Appendices.

Dimensions

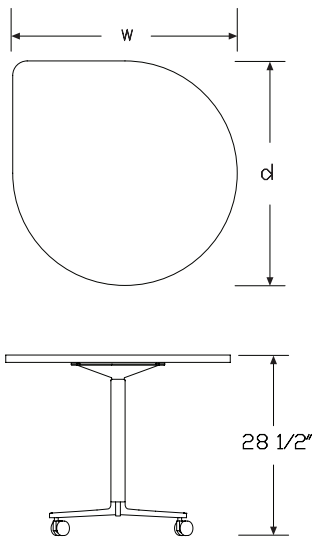

Specification Information

Step 1.

DT1K A

Step 2. Edge

- S.** squared-edge
- T.** thin-edge
- E.** eased-edge

Step 3. Diameter

- 30** 30" diameter
- 36** 36" diameter

Step 4. Surface Material

For eased-edge (E.)

- P** painted Formcoat® top/edge

For thin-edge (T.)

- W** veneer top/veneer edge
- P** painted Formcoat® top/edge

For squared-edge (S.)

- L** laminate top/thermoplastic edge
- W** veneer top/veneer edge
- P** painted Formcoat® top/edge

Step 5. Leg/Base Type

- S** single-column base A

Prices for Steps 1-5.

	S
DT1KS. 30 L	\$922
W	\$1168
P	\$1058
36 L	\$1054
W	\$1418
P	\$1213
	S
DT1KT. 30 W	\$1404
P	\$1127
36 W	\$1701
P	\$1292
	S
DT1KE. 30 P	\$1127

Tear Drop Table *continued*

Everywhere™ Standard-Height Tables

36 P \$1292

Step 6.

Top Finish

For laminate top/thermoplastic edge (L)

28	canyon	+\$0
29	misted	+\$0
38	twilight	+\$0
39	desert	+\$0
76	light brown walnut	+\$0
91	white	+\$0
98	studio white	+\$0
1X	vanilla	+\$0
2X	wheat	+\$0
3X	celery	+\$0
4X	coriander	+\$0
5X	chamomile	+\$0
6X	cinnamon	+\$0
7X	cardamom	+\$0
8X	kale	+\$0
8Q	folkstone grey	+\$0
CL	cool grey neutral	+\$0
HF	inner tone light	+\$0
HM	natural maple	+\$0
HP	light anigre	+\$0
HT	inner tone	+\$0
HX	aged cherry	+\$0
HY	walnut on cherry	+\$0
J4	frosted light grey	+\$0
LA	light ash	+\$0
LBA	clear on ash	+\$0
LBR	phantom ecru	+\$0
LBS	phantom cocoa	+\$0
LBU	medium matte walnut	+\$0
LBV	warm grey teak	+\$0
LBB	oak on ash	+\$0
LBC	walnut on ash	+\$0
LBD	dark brown walnut	+\$0
LBE	medium red walnut	+\$0
LBF	neutral twill	+\$0
LBG	sarum twill	+\$0
LBH	earthen twill	+\$0
LBJ	graphite twill	+\$0
LBK	pewter mesh	+\$0
LBL	steel mesh	+\$0
LBM	crisp linen	+\$0

LBN	classic linen	+\$0
LBP	casual linen	+\$0
LBQ	white twill	+\$0
LG	light grey (discontinuing)	+\$0
LM	mahogany	+\$0
LT	light tone	+\$0
LU	soft white	+\$0
MT	medium tone	+\$0
OG	honey maple	+\$0
WL	sandstone	+\$0
WN	warm grey neutral	+\$0
X1	chalk white	+\$0

Top/Edge Finish: Opaque Formcoat®

For painted Formcoat® top/edge (P)

8Q	folkstone grey	+\$0
91	white	+\$0
CL	cool grey neutral	+\$0
LU	soft white	+\$0
WL	sandstone	+\$0
WN	warm grey neutral	+\$0

Top/Edge Finish: Wood Veneer

For veneer top/veneer edge (W)

2U	light brown walnut <input type="checkbox"/>	+\$85
40	dark brown walnut <input type="checkbox"/>	+\$85
ED	aged cherry <input type="checkbox"/>	+\$85
EK	medium red walnut <input type="checkbox"/>	+\$85
EW	medium matte walnut <input type="checkbox"/>	+\$85
ET	clear on ash	+\$85
EU	oak on ash	+\$85
EV	walnut on ash	+\$85
EY	light anigre <input type="checkbox"/>	+\$85
UL	natural maple <input type="checkbox"/>	+\$85
UX	walnut on cherry <input type="checkbox"/>	+\$85

Step 7. Edge Finish

For laminate top/thermoplastic edge (L)

76	light brown walnut	+\$0
8Q	folkstone grey	+\$0
91	white	+\$0
98	studio white	+\$0
CL	cool grey neutral	+\$0
LA	light ash	+\$0
LBA	clear on ash	+\$0
LBR	phantom ecru	+\$0
LBS	phantom cocoa	+\$0

Tear Drop Table *continued*

LBU	medium matte walnut	+\$0
LBV	warm grey teak	+\$0
LBB	oak on ash	+\$0
LBC	walnut on ash	+\$0
LBD	dark brown walnut	+\$0
LBE	medium red walnut	+\$0
LBF	neutral twill	+\$0
LBG	sarum twill	+\$0
LBH	earthen twill	+\$0
LBJ	graphite twill	+\$0
LBK	pewter mesh	+\$0
LBL	steel mesh	+\$0
LBM	crisp linen	+\$0
LBN	classic linen	+\$0
LBP	casual linen	+\$0
LBQ	white twill	+\$0
WL	sandstone	+\$0
WN	warm grey neutral	+\$0
HF	inner tone light	+\$0
HM	natural maple	+\$0
HP	light anigre	+\$0
HT	inner tone	+\$0
HX	aged cherry	+\$0
HY	walnut on cherry	+\$0
LU	soft white	+\$0

Step 8. Leg/Base Finish

8Q	folkstone grey	+\$0
91	white	+\$0
98	studio white A	+\$0
BU	black umber	+\$0
CL	cool grey neutral	+\$0
G2	graphite satin	+\$0
HF	inner tone light	+\$0
LU	soft white	+\$0
MT	medium tone	+\$0
SG	slate grey	+\$0
WL	sandstone	+\$0
WN	warm grey neutral	+\$0
CN	metallic champagne	+\$0
EH	metallic bronze	+\$0
MS	metallic silver	+\$0
CD	polished aluminum	+\$110

Step 9. Casters/Glides

20	casters	+\$0
57	glides	+\$0

Classroom Curve Table

DT1LE.
DT1LS.
DT1LT.

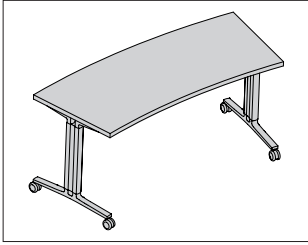

Product Information

Description
This classroom table comes in multiple edge styles and has a laminate top with thermoplastic edge, veneer top and edge, or painted top and edge. It has multiple leg options, and is available with casters or glides. The caster option has 2 locking and 2 non-locking casters. Glides have 1/2" leveling range. Shipped knocked down. Height-adjustable legs have a 5" range in 1" increments.

Notes
Cable grommet options available through Vary Easy Program for round pass through grommet with 2 1/4" hole clearance. Holes are located 3" from rear edge and 6" from end for the L and R options. Covers not provided with painted surface option. Reinforcement channels are used under table tops 54" and wider. They will be located along the center line for 18" deep and 24" deep surfaces, and 19" from the front edge for 30" deep surfaces. For additional details on available edge options see Appendices. For additional size, edge, finish, and cable management options, see Vary Easy Program in Appendices. UL listed when used with Connect™ single circuit electrical product (Y137x.) with post leg (P) and T-leg (T) options.

Dimensions

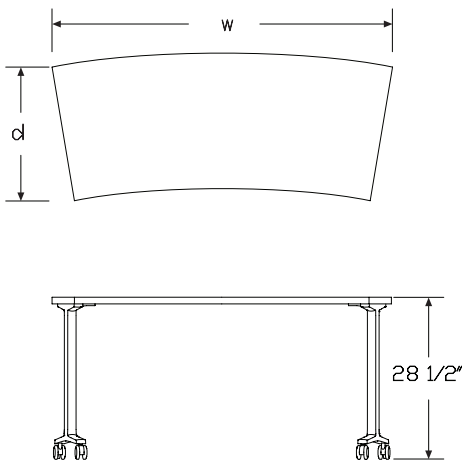

Specification Information

Step 1.

DT1L

Step 2. Edge

- S.** squared-edge
- T.** thin-edge
- E.** eased-edge

Step 3. Depth

For squared-edge (S.)

- 18** 18" deep
- 24** 24" deep

For thin-edge (T.)

- 24** 24" deep

For eased-edge (E.)

- 24** 24" deep

Step 4. Width

For 18" deep (18)

- 60** 60" wide

For 24" deep (24)

- 48** 48" wide
- 60** 60" wide

Step 5. Surface Material

For squared-edge (S.)

- L** laminate top/thermoplastic edge
- W** veneer top/veneer edge **A**
- P** painted Formcoat® top/edge

For thin-edge (T.)

- W** veneer top/veneer edge **A**
- P** painted Formcoat® top/edge

For eased-edge (E.)

- P** painted Formcoat® top/edge

Classroom Curve Table *continued*

Step 6. Leg Type

For 18" deep (18)

P post leg

For 24" deep (24)

P post leg

T T-leg

A T-leg with height adjustment

Prices for Steps 1-6.

	LP	LT	LA	WP	WT	WA
DT1LS. 18 60	\$1038	—	—	1272	—	—
24 48	\$1039	1349	1688	1274	1678	2116
60	\$1167	1518	1896	1442	1896	2389

	PP	PT	PA
DT1LS. 18 60	\$1193	—	—
24 48	\$1194	1552	1941
60	\$1343	1745	2178

	LP	LT	LA	WP	WT	WA
DT1LT. 24 48	—	—	—	\$1529	2015	2538
60	—	—	—	\$1729	2273	2865

	PP	PT	PA
DT1LT. 24 48	\$1271	1654	2066
60	\$1430	1858	2321

	PP	PT	PA
DT1LE. 24 48	\$1271	1654	2066
60	\$1430	1858	2321

Step 7.

Top Finish

For laminate top/thermoplastic edge (L)

28	canyon	+\$0
29	misted	+\$0
38	twilight	+\$0
39	desert	+\$0
76	light brown walnut	+\$0
91	white	+\$0
98	studio white	+\$0
1X	vanilla	+\$0
2X	wheat	+\$0
3X	celery	+\$0

4X	coriander	+\$0
5X	chamomile	+\$0
6X	cinnamon	+\$0
7X	cardamom	+\$0
8X	kale	+\$0
8Q	folkstone grey	+\$0
CL	cool grey neutral	+\$0
HF	inner tone light	+\$0
HM	natural maple	+\$0
HP	light anigre	+\$0
HT	inner tone	+\$0
HX	aged cherry	+\$0
HY	walnut on cherry	+\$0
J4	frosted light grey	+\$0
LA	light ash	+\$0
LBA	clear on ash	+\$0
LBR	phantom ecru	+\$0
LBS	phantom cocoa	+\$0
LBU	medium matte walnut	+\$0
LBV	warm grey teak	+\$0
LBB	oak on ash	+\$0
LBC	walnut on ash	+\$0
LBD	dark brown walnut	+\$0
LBE	medium red walnut	+\$0
LBF	neutral twill	+\$0
LBG	sarum twill	+\$0
LBH	earthen twill	+\$0
LBJ	graphite twill	+\$0
LBK	pewter mesh	+\$0
LBL	steel mesh	+\$0
LBM	crisp linen	+\$0
LBN	classic linen	+\$0
LBP	casual linen	+\$0
LBQ	white twill	+\$0
LG	light grey (discontinuing)	+\$0
LM	mahogany	+\$0
LT	light tone	+\$0
LU	soft white	+\$0
MT	medium tone	+\$0
OG	honey maple	+\$0
WL	sandstone	+\$0
WN	warm grey neutral	+\$0
X1	chalk white	+\$0

Classroom Curve Table *continued*

Everywhere™ Standard-Height Tables

Top/Edge Finish: Wood Veneer		
<i>For veneer top/veneer edge (W)</i>		
2U	light brown walnut A	+\$85
40	dark brown walnut A	+\$85
ED	aged cherry A	+\$85
EK	medium red walnut A	+\$85
EW	medium matte walnut A	+\$85
ET	clear on ash A	+\$85
EU	oak on ash A	+\$85
EV	walnut on ash A	+\$85
UL	natural maple A	+\$85
UX	walnut on cherry A	+\$85

Top/Edge Finish: Opaque Formcoat®		
<i>For painted Formcoat® top/edge (P)</i>		
8Q	folkstone grey	+\$0
91	white	+\$0
CL	cool grey neutral	+\$0
LU	soft white	+\$0
WL	sandstone	+\$0
WN	warm grey neutral	+\$0

Step 8. Edge Finish		
<i>For laminate top/thermoplastic edge (L)</i>		
76	light brown walnut	+\$0
8Q	folkstone grey	+\$0
91	white	+\$0
98	studio white	+\$0
CL	cool grey neutral	+\$0
LA	light ash	+\$0
LBA	clear on ash	+\$0
LBR	phantom ecru	+\$0
LBS	phantom cocoa	+\$0
LBU	medium matte walnut	+\$0
LBV	warm grey teak	+\$0
LBB	oak on ash	+\$0
LBC	walnut on ash	+\$0
LBD	dark brown walnut	+\$0
LBE	medium red walnut	+\$0
LBF	neutral twill	+\$0
LBG	sarum twill	+\$0
LBH	earthen twill	+\$0
LBJ	graphite twill	+\$0
LBK	pewter mesh	+\$0
LBL	steel mesh	+\$0
LBM	crisp linen	+\$0
LBN	classic linen	+\$0

LBP	casual linen	+\$0
LBQ	white twill	+\$0
WL	sandstone	+\$0
WN	warm grey neutral	+\$0
HF	inner tone light	+\$0
HM	natural maple	+\$0
HP	light anigre	+\$0
HT	inner tone	+\$0
HX	aged cherry	+\$0
HY	walnut on cherry	+\$0
LU	soft white	+\$0

Step 9. Leg Finish		
8Q	folkstone grey	+\$0
91	white	+\$0
98	studio white A	+\$0
BU	black umber	+\$0
CL	cool grey neutral	+\$0
G2	graphite satin	+\$0
HF	inner tone light	+\$0
LU	soft white	+\$0
MT	medium tone	+\$0
SG	slate grey	+\$0
WL	sandstone	+\$0
WN	warm grey neutral	+\$0
CN	metallic champagne	+\$0
EH	metallic bronze	+\$0
MS	metallic silver	+\$0
CD	polished aluminum	+\$110

Step 10. Casters/Glides		
20	casters	+\$0
57	glides	+\$0

Conference Corner Table

DT1ME.
DT1MS.
DT1MT.

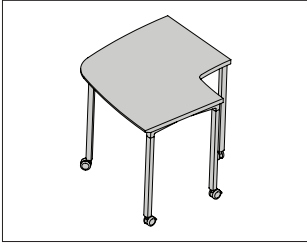

Product Information

Description

This corner table comes in multiple edge styles and has a laminate top with thermoplastic edge, veneer top and edge, or painted top and edge. It has multiple leg/base options, and is available with casters or glides. The caster option has 2 locking and 2 non-locking casters. Glides have 1/2" leveling range. Shipped knocked down.

Notes

Tables have an additional (5th) leg for stability.
Additional ganging bracket kits (Y1338.) can be used with adjacent tables.
For additional details on available edge options see Appendices.

Dimensions

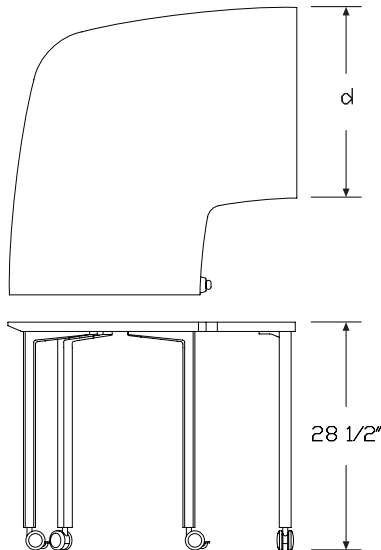

Specification Information

Step 1.

DT1M

Step 2. Edge

- S.** squared-edge
- T.** thin-edge
- E.** eased-edge

Step 3. Depth

- 24** 24" deep
- 30** 30" deep

Step 4. Surface Material

For squared-edge (S.)

- L** laminate top/thermoplastic edge
- W** veneer top/veneer edge **A**
- P** painted Formcoat® top/edge

For thin-edge (T.)

- W** veneer top/veneer edge **A**
- P** painted Formcoat® top/edge

For eased-edge (E.)

- P** painted Formcoat® top/edge

Step 5. Leg/Base Type

- P** post leg

Prices for Steps 1-5.

	P
DT1MS.24 L	\$1164
W	\$1471
P	\$1340
30 L	\$1398
W	\$1785
P	\$1606
	P
DT1MT.24 W	\$1766
P	\$1425
30 W	\$2144
P	\$1710
	P
DT1ME.24 P	\$1425

Conference Corner Table *continued*

Everywhere™ Standard-Height Tables

30 P \$1710

Step 6.

Top Finish

For laminate top/thermoplastic edge (L)

28	canyon	+\$0
29	misted	+\$0
38	twilight	+\$0
39	desert	+\$0
76	light brown walnut	+\$0
91	white	+\$0
98	studio white	+\$0
1X	vanilla	+\$0
2X	wheat	+\$0
3X	celery	+\$0
4X	coriander	+\$0
5X	chamomile	+\$0
6X	cinnamon	+\$0
7X	cardamom	+\$0
8X	kale	+\$0
8Q	folkstone grey	+\$0
CL	cool grey neutral	+\$0
HF	inner tone light	+\$0
HM	natural maple	+\$0
HP	light anigre	+\$0
HT	inner tone	+\$0
HX	aged cherry	+\$0
HY	walnut on cherry	+\$0
J4	frosted light grey	+\$0
LA	light ash	+\$0
LBA	clear on ash	+\$0
LBR	phantom ecru	+\$0
LBS	phantom cocoa	+\$0
LBU	medium matte walnut	+\$0
LBV	warm grey teak	+\$0
LBB	oak on ash	+\$0
LBC	walnut on ash	+\$0
LBD	dark brown walnut	+\$0
LBE	medium red walnut	+\$0
LBF	neutral twill	+\$0
LBG	sarum twill	+\$0
LBH	earthen twill	+\$0
LBJ	graphite twill	+\$0
LBK	pewter mesh	+\$0
LBL	steel mesh	+\$0
LBM	crisp linen	+\$0

LBN	classic linen	+\$0
LBP	casual linen	+\$0
LBQ	white twill	+\$0
LG	light grey (discontinuing)	+\$0
LM	mahogany	+\$0
LT	light tone	+\$0
LU	soft white	+\$0
MT	medium tone	+\$0
OG	honey maple	+\$0
WL	sandstone	+\$0
WN	warm grey neutral	+\$0
X1	chalk white	+\$0

Top/Edge Finish: Wood Veneer

For veneer top/veneer edge (W)

2U	light brown walnut <input type="checkbox"/> A	+\$85
40	dark brown walnut <input type="checkbox"/> A	+\$85
ED	aged cherry <input type="checkbox"/> A	+\$85
EK	medium red walnut <input type="checkbox"/> A	+\$85
EW	medium matte walnut <input type="checkbox"/> A	+\$85
ET	clear on ash <input type="checkbox"/> A	+\$85
EU	oak on ash <input type="checkbox"/> A	+\$85
EV	walnut on ash <input type="checkbox"/> A	+\$85
UL	natural maple <input type="checkbox"/> A	+\$85
UX	walnut on cherry <input type="checkbox"/> A	+\$85

Top/Edge Finish: Opaque Formcoat®

For painted Formcoat® top/edge (P)

8Q	folkstone grey	+\$0
91	white	+\$0
CL	cool grey neutral	+\$0
LU	soft white	+\$0
WL	sandstone	+\$0
WN	warm grey neutral	+\$0

Step 7. Edge Finish

For laminate top/thermoplastic edge (L)

76	light brown walnut	+\$0
8Q	folkstone grey	+\$0
91	white	+\$0
98	studio white	+\$0
CL	cool grey neutral	+\$0
LA	light ash	+\$0
LBA	clear on ash	+\$0
LBR	phantom ecru	+\$0
LBS	phantom cocoa	+\$0
LBU	medium matte walnut	+\$0

Conference Corner Table *continued*

LBV	warm grey teak	+\$0
LBB	oak on ash	+\$0
LBC	walnut on ash	+\$0
LBD	dark brown walnut	+\$0
LBE	medium red walnut	+\$0
LBF	neutral twill	+\$0
LBG	sarum twill	+\$0
LBH	earthen twill	+\$0
LBJ	graphite twill	+\$0
LBK	pewter mesh	+\$0
LBL	steel mesh	+\$0
LBM	crisp linen	+\$0
LBN	classic linen	+\$0
LBP	casual linen	+\$0
LBQ	white twill	+\$0
WL	sandstone	+\$0
WN	warm grey neutral	+\$0
HF	inner tone light	+\$0
HM	natural maple	+\$0
HP	light anigre	+\$0
HT	inner tone	+\$0
HX	aged cherry	+\$0
HY	walnut on cherry	+\$0
LU	soft white	+\$0

Step 8. Leg/Base Finish

8Q	folkstone grey	+\$0
91	white	+\$0
98	studio white	+\$0
BU	black umber	+\$0
CL	cool grey neutral	+\$0
G2	graphite satin	+\$0
HF	inner tone light	+\$0
LU	soft white	+\$0
MT	medium tone	+\$0
SG	slate grey	+\$0
WL	sandstone	+\$0
WN	warm grey neutral	+\$0
CN	metallic champagne	+\$0
EH	metallic bronze	+\$0
MS	metallic silver	+\$0
CD	polished aluminum	+\$110

Step 9. Casters/Glides

20	casters	+\$0
57	glides	+\$0

Round Corner Table

DT1NE.
DT1NS.
DT1NT.

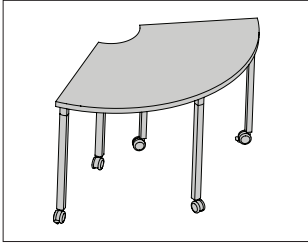

Product Information

Description
This corner table comes in multiple edge styles and has a laminate top with thermoplastic edge, veneer top and edge, or painted top and edge. It has multiple leg/base options, and is available with casters or glides. The caster option has 2 locking and 2 non-locking casters. Glides have 1/2" leveling range. Shipped knocked down.

Notes

Tables have an additional (5th) leg for stability.
3 36" deep tables ganged together make an 84" diameter table.
Additional ganging bracket kits (Y1338.), sold separately, can be used to ensure proper alignment with adjacent tables.
For additional details on available edge options see Appendices.
UL listed when used with Connect™ single circuit electrical product (Y137x.) with post leg (P) option.

Dimensions

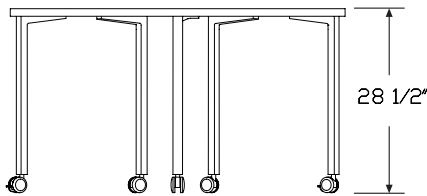
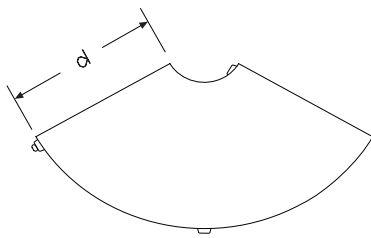

Specification Information

Step 1.

DT1N

Step 2. Edge

- S. squared-edge
- T. thin-edge
- E. eased-edge

Step 3. Depth

- 24 24" deep
- 30 30" deep
- 36 36" deep

Step 4. Surface Material

For squared-edge (S.)

- L laminate top/thermoplastic edge
- W veneer top/veneer edge **A**
- P painted Formcoat® top/edge

For thin-edge (T.)

- W veneer top/veneer edge **A**
- P painted Formcoat® top/edge

For eased-edge (E.)

- P painted Formcoat® top/edge

Step 5. Leg/Base Type

- P post leg

Prices for Steps 1-5.

	P
DT1NS. 24 L	\$1164
W	\$1471
P	\$1340
30 L	\$1398
W	\$1785
P	\$1606
36 L	\$1630
W	\$2101
P	\$1874
	P
DT1NT. 24 W	\$1766
P	\$1425

Round Corner Table *continued*

30 W	\$2144
P	\$1710
36 W	\$2520
P	\$1996
	P
DT1NE. 24 P	\$1425
30 P	\$1710
36 P	\$1996

Step 6.

Top Finish

For laminate top/thermoplastic edge (L)

28	canyon	+\$0
29	misted	+\$0
38	twilight	+\$0
39	desert	+\$0
76	light brown walnut	+\$0
91	white	+\$0
98	studio white	+\$0
1X	vanilla	+\$0
2X	wheat	+\$0
3X	celery	+\$0
4X	coriander	+\$0
5X	chamomile	+\$0
6X	cinnamon	+\$0
7X	cardamom	+\$0
8X	kale	+\$0
8Q	folkstone grey	+\$0
CL	cool grey neutral	+\$0
HF	inner tone light	+\$0
HM	natural maple	+\$0
HP	light anigre	+\$0
HT	inner tone	+\$0
HX	aged cherry	+\$0
HY	walnut on cherry	+\$0
J4	frosted light grey	+\$0
LA	light ash	+\$0
LBA	clear on ash	+\$0
LBR	phantom ecru	+\$0
LBS	phantom cocoa	+\$0
LBU	medium matte walnut	+\$0
LBV	warm grey teak	+\$0
LBB	oak on ash	+\$0
LBC	walnut on ash	+\$0
LBD	dark brown walnut	+\$0

LBE	medium red walnut	+\$0
LBF	neutral twill	+\$0
LBG	sarum twill	+\$0
LBH	earthen twill	+\$0
LBJ	graphite twill	+\$0
LBK	pewter mesh	+\$0
LBL	steel mesh	+\$0
LBM	crisp linen	+\$0
LBN	classic linen	+\$0
LBP	casual linen	+\$0
LBQ	white twill	+\$0
LG	light grey (discontinuing)	+\$0
LM	mahogany	+\$0
LT	light tone	+\$0
LU	soft white	+\$0
MT	medium tone	+\$0
OG	honey maple	+\$0
WL	sandstone	+\$0
WN	warm grey neutral	+\$0
X1	chalk white	+\$0

Top/Edge Finish: Wood Veneer

For veneer top/veneer edge (W)

2U	light brown walnut <input type="checkbox"/> A	+\$85
40	dark brown walnut <input type="checkbox"/> A	+\$85
ED	aged cherry <input type="checkbox"/> A	+\$85
EK	medium red walnut <input type="checkbox"/> A	+\$85
EW	medium matte walnut <input type="checkbox"/> A	+\$85
ET	clear on ash <input type="checkbox"/> A	+\$85
EU	oak on ash <input type="checkbox"/> A	+\$85
EV	walnut on ash <input type="checkbox"/> A	+\$85
UL	natural maple <input type="checkbox"/> A	+\$85
UX	walnut on cherry <input type="checkbox"/> A	+\$85

Top/Edge Finish: Opaque Formcoat®

For painted Formcoat® top/edge (P)

8Q	folkstone grey	+\$0
91	white	+\$0
CL	cool grey neutral	+\$0
LU	soft white	+\$0
WL	sandstone	+\$0
WN	warm grey neutral	+\$0

Step 7. Edge Finish

For laminate top/thermoplastic edge (L)

76	light brown walnut	+\$0
8Q	folkstone grey	+\$0

Round Corner Table *continued*

Everywhere™ Standard-Height Tables

91	white	+\$0
98	studio white	+\$0
CL	cool grey neutral	+\$0
LA	light ash	+\$0
LBA	clear on ash	+\$0
LBR	phantom ecru	+\$0
LBS	phantom cocoa	+\$0
LBU	medium matte walnut	+\$0
LBV	warm grey teak	+\$0
LBB	oak on ash	+\$0
LBC	walnut on ash	+\$0
LBD	dark brown walnut	+\$0
LBE	medium red walnut	+\$0
LBF	neutral twill	+\$0
LBG	sarum twill	+\$0
LBH	earthen twill	+\$0
LBJ	graphite twill	+\$0
LBK	pewter mesh	+\$0
LBL	steel mesh	+\$0
LBM	crisp linen	+\$0
LBN	classic linen	+\$0
LBP	casual linen	+\$0
LBQ	white twill	+\$0
WL	sandstone	+\$0
WN	warm grey neutral	+\$0
HF	inner tone light	+\$0
HM	natural maple	+\$0
HP	light anigre	+\$0
HT	inner tone	+\$0
HX	aged cherry	+\$0
HY	walnut on cherry	+\$0
LU	soft white	+\$0

Step 8. Leg/Base Finish

98	studio white	+\$0
8Q	folkstone grey	+\$0
91	white	+\$0
BU	black umber	+\$0
CL	cool grey neutral	+\$0
G2	graphite satin	+\$0
HF	inner tone light	+\$0
LU	soft white	+\$0
MT	medium tone	+\$0
SG	slate grey	+\$0
WL	sandstone	+\$0
WN	warm grey neutral	+\$0
CN	metallic champagne	+\$0
EH	metallic bronze	+\$0
MS	metallic silver	+\$0
CD	polished aluminum	+\$110

Step 9. Casters/Glides

20	casters	+\$0
57	glides	+\$0

Flip-Top Rectangular Table

DT5AE.
DT5AS.
DT5AT.

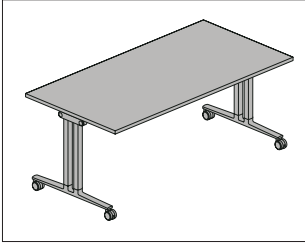

Product Information

Description

This rectangular table comes in multiple edge styles and has a laminate top with thermoplastic edge, laminate top with a thermoplastic backed plywood edge, veneer top and edge, or painted top and edge. It has 2 paddles under the front edge that allow the surface to flip up, minimizing space for storage when not in use. The table has T-legs and is available with casters or glides. The caster option has 2 locking and 2 non-locking casters. Glides have 1/2" leveling range. Shipped knocked down.

Notes

Thin edge and eased edge tops not available with 18"-deep surfaces.
Cable grommet options available through Vary Easy Program for round pass through grommet with 2 1/4" hole clearance. Holes are located 3" from rear edge and 6" from end for the L and R options. Covers not provided with painted surface option.
Cutouts available for all Connect™ power and data accessories (see Thrive® Portfolio). Cutouts will be located in the center, laterally, and approximately 3" from the rear edge of surface.
Multiple tables can be nested for storage when surface is flipped up. First table in nest requires 23" of floor space. All additional tables require only 9" of additional space.
Table top overhangs the base by 2 3/4" on each end.
For additional details on available edge options see Appendices.
Only fabric modesty panel (Y1114.) will enable flip top table to fold as intended. It is the recommended modesty panel for use with flip top tables. It is full length and folds out of the way for table storage.
For additional size, edge, finish, and cable management options, see Vary Easy Program in Appendices.
UL listed when used with Connect single circuit electrical product (Y137x.) with T-leg (T) option.

Dimensions

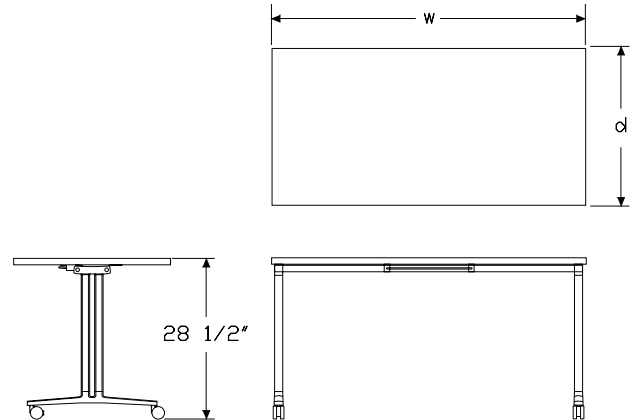

Flip-Top Rectangular Table *continued*

Everywhere™ Standard-Height Tables

Specification Information	
Step 1.	
DT5A	
Step 2. Edge	
S.	squared-edge
T.	thin-edge
E.	eased-edge
Step 3. Depth	
<i>For squared-edge (S.)</i>	
18	18" deep
24	24" deep
30	30" deep
<i>For eased-edge (E.)</i>	
24	24" deep
30	30" deep
<i>For thin-edge (T.)</i>	
24	24" deep
30	30" deep
Step 4. Width	
48	48" wide
60	60" wide
72	72" wide
Step 5. Surface Material	
<i>For squared-edge (S.)</i>	
L	lamine top/thermoplastic edge
U	lamine top/universal edge
W	veneer top/veneer edge A
P	painted Formcoat® top/edge
<i>For thin-edge (T.)</i>	
W	veneer top/veneer edge A
P	painted Formcoat® top/edge
<i>For eased-edge (E.)</i>	
P	painted Formcoat® top/edge
Step 6. Leg Type	
T	T-leg

Prices for Steps 1-6.				
	LT	UT	WT	PT
DT5AS. 18 48	\$1464	1464	1775	1685
60	\$1536	1536	1870	1767
72	\$1614	1614	1965	1855
24 48	\$1494	1494	1812	1718
60	\$1568	1568	1909	1805
72	\$1646	1646	2005	1895
30 48	\$1584	1584	1924	1820
60	\$1726	1726	2102	1984
72	\$1812	1812	2209	2083
DT5AT. 24 48	—	—	\$2174	1831
60	—	—	\$2289	1921
72	—	—	\$2405	2017
30 48	—	—	\$2310	1940
60	—	—	\$2521	2114
72	—	—	\$2650	2219
DT5AE. 24 48	—	—	—	\$1831
60	—	—	—	\$1921
72	—	—	—	\$2017
30 48	—	—	—	\$1940
60	—	—	—	\$2114
72	—	—	—	\$2219

Flip-Top Rectangular Table *continued*

Step 7.

Top Finish

For laminate top/thermoplastic edge (L) or laminate top/universal edge (U)

76	light brown walnut	+\$0
91	white	+\$0
98	studio white	+\$0
8Q	folkstone grey	+\$0
CL	cool grey neutral	+\$0
HF	inner tone light	+\$0
HM	natural maple	+\$0
HP	light anigre	+\$0
HT	inner tone	+\$0
HX	aged cherry	+\$0
HY	walnut on cherry	+\$0
LA	light ash	+\$0
LBA	clear on ash	+\$0
LBR	phantom ecru	+\$0
LBS	phantom cocoa	+\$0
LBU	medium matte walnut	+\$0
LBV	warm grey teak	+\$0
LBB	oak on ash	+\$0
LBC	walnut on ash	+\$0
LBD	dark brown walnut	+\$0
LBE	medium red walnut	+\$0
LBF	neutral twill	+\$0
LBG	sarum twill	+\$0
LBH	earthen twill	+\$0
LBJ	graphite twill	+\$0
LBK	pewter mesh	+\$0
LBL	steel mesh	+\$0
LBM	crisp linen	+\$0
LBN	classic linen	+\$0
LBP	casual linen	+\$0
LBQ	white twill	+\$0
LU	soft white	+\$0
WL	sandstone	+\$0
WN	warm grey neutral	+\$0

Top/Edge Finish: Wood Veneer

For veneer top/veneer edge (W)

2U	light brown walnut A	+\$50
40	dark brown walnut A	+\$50
ED	aged cherry A	+\$50
EK	medium red walnut A	+\$50
EW	medium matte walnut A	+\$50
ET	clear on ash A	+\$50
EU	oak on ash A	+\$50
EV	walnut on ash A	+\$50
UL	natural maple A	+\$50
UX	walnut on cherry A	+\$50

Top/Edge Finish: Opaque Formcoat®

For painted Formcoat® top/edge (P)

8Q	folkstone grey	+\$0
91	white	+\$0
CL	cool grey neutral	+\$0
LU	soft white	+\$0
WL	sandstone	+\$0
WN	warm grey neutral	+\$0

Flip-Top Rectangular Table *continued*

Everywhere™ Standard-Height Tables

Step 8. Edge Finish

For laminate top/thermoplastic edge (L)

76	light brown walnut	+\$0
8Q	folkstone grey	+\$0
91	white	+\$0
98	studio white	+\$0
CL	cool grey neutral	+\$0
LA	light ash	+\$0
LBA	clear on ash	+\$0
LBR	phantom ecru	+\$0
LBS	phantom cocoa	+\$0
LBU	medium matte walnut	+\$0
LBV	warm grey teak	+\$0
LBB	oak on ash	+\$0
LBC	walnut on ash	+\$0
LBD	dark brown walnut	+\$0
LBE	medium red walnut	+\$0
LBF	neutral twill	+\$0
LBG	sarum twill	+\$0
LBH	earthen twill	+\$0
LBJ	graphite twill	+\$0
LBK	pewter mesh	+\$0
LBL	steel mesh	+\$0
LBM	crisp linen	+\$0
LBN	classic linen	+\$0
LBP	casual linen	+\$0
LBQ	white twill	+\$0
WL	sandstone	+\$0
WN	warm grey neutral	+\$0
HF	inner tone light	+\$0
HM	natural maple	+\$0
HP	light anigre	+\$0
HT	inner tone	+\$0
HX	aged cherry	+\$0
HY	walnut on cherry	+\$0
LU	soft white	+\$0

For laminate top/universal edge (U)

PLY	plywood edge	+\$50
------------	--------------	-------

Step 9. Leg Finish

8Q	folkstone grey	+\$0
91	white	+\$0
98	studio white A	+\$0
BU	black umber	+\$0
CL	cool grey neutral	+\$0
G2	graphite satin	+\$0
HF	inner tone light	+\$0
LU	soft white	+\$0
MT	medium tone	+\$0
SG	slate grey	+\$0
WL	sandstone	+\$0
WN	warm grey neutral	+\$0
CN	metallic champagne	+\$0
EH	metallic bronze	+\$0
MS	metallic silver	+\$0
CD	polished aluminum	+\$110

Step 10. Casters/Glides

20	casters	+\$0
57	glides	+\$0

Standard-Height Table Leg

DT2A.

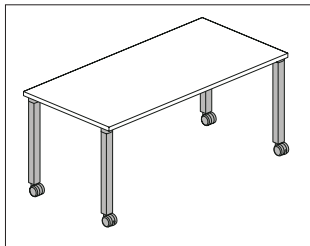

Product Information

Description

This product is a kit of a full set of table legs with attachment hardware. It has multiple leg options, and is available with casters or glides. The caster option has 2 locking and 2 non-locking casters. Glides have 1/2" leveling range. Shipped knocked down.

Notes

Height adjustable table legs have a 5" range in 1" increments.

Tabletop must be no more than 30" deep and no less than 24" deep for C and D options. Tabletop must be no more than 36" deep and no less than 18" deep for P, A, and T options.

Tabletops 54" and wider are recommended to have a steel support channel.

Not recommended for tables wider than 84".

Table leg must be located such that the floor glides are not more than 3" from the front and rear sides for table stability.

Tabletop can over hang sides of table base by no more than 15" for tops 60" and wider.

1" long screws provided with base are recommended to attach to tabletop. Ensure mounting surface is no less than 1" thick.

Dimensions

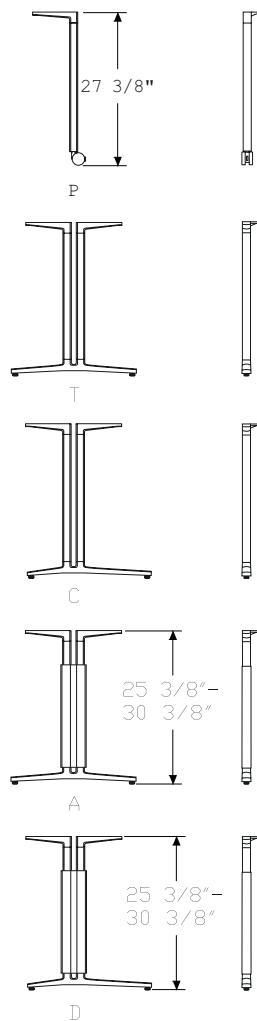

Standard-Height Table Leg *continued*

Everywhere™ Standard-Height Table Legs and Bases

Specification Information

Step 1.

DT2A.

Step 2. Depth

18	18" deep
24	24" deep
30	30" deep
36	36" deep

Step 3. Leg Type

For 18" deep (18) or 36" deep (36)

P	post leg
T	T-leg
A	T-leg with height adjustment

For 24" deep (24) or 30" deep (30)

P	post leg
T	T-leg
A	T-leg with height adjustment
C	C-leg
D	C-leg with height adjustment

Step 4. Table Top Surface Material

For post leg (P)

P	painted table top
Z	laminated or veneer table top

For T-leg (T), T-leg with height adjustment (A), C-leg (C), or C-leg with height adjustment (D)

N	laminated, painted or veneer table top
----------	--

Prices for Steps 1-4.

		N	P	Z
DT2A.	18 P	—	\$547	547
	T	\$693	—	—
	A	\$1055	—	—
	24 P	—	\$547	547
	T	\$717	—	—
	A	\$1091	—	—
	C	\$717	—	—
	D	\$1105	—	—

30 P	—	\$547	547
T	\$717	—	—
A	\$1091	—	—
C	\$717	—	—
D	\$1105	—	—
36 P	—	\$547	547
T	\$756	—	—
A	\$1130	—	—

Step 5. Leg Finish

8Q	folkstone grey	+\$0
91	white	+\$0
98	studio white	+\$0
BU	black umber	+\$0
CL	cool grey neutral	+\$0
G2	graphite satin	+\$0
HF	inner tone light	+\$0
LU	soft white	+\$0
MT	medium tone	+\$0
SG	slate grey	+\$0
WL	sandstone	+\$0
WN	warm grey neutral	+\$0
CN	metallic champagne	+\$0
EH	metallic bronze	+\$0
MS	metallic silver	+\$0
CD	polished aluminum	+\$110

Step 6. Casters/Glides

20	casters	+\$0
57	glides	+\$0

Standard-Height Table Base

DT2B.

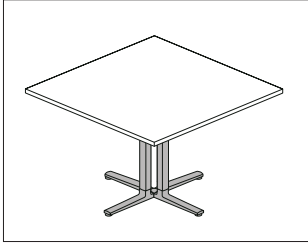

Product Information

Description

This product is a kit of a full set of center column table legs with attachment hardware. It has either single column S or 4 column X leg options, and is available with casters or glides. The caster option has 2 locking and 2 non-locking casters. Glides have 1/2" leveling range. Shipped knocked down.

Notes

Tabletop must be no more than 42" deep and no less than 30" deep for X base.

Tabletop must be no more than 36" deep and no less than 24" deep for S base.

Table base to be centered side-to-side and left-to-right under tabletop.

Tabletop can over hang sides of table base by no more than 15" for tops 60" and wider.

1" long screws provided with base are recommended to attach to tabletop. Ensure mounting surface is no less than 1" thick.

Dimensions

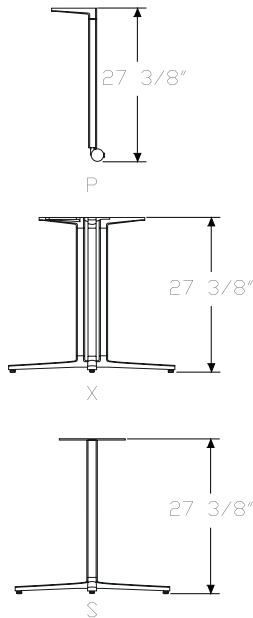

Specification Information

Step 1.

DT2B.

Step 2. Leg/Base Type

X 4-column base
S single-column base

Prices for Steps 1-2.

DT2B. X \$764
S \$532

Step 3. Leg/Base Finish

8Q	folkstone grey	+\$0
91	white	+\$0
98	studio white <input type="checkbox"/> A	+\$0
BU	black umber	+\$0
CL	cool grey neutral	+\$0
G2	graphite satin	+\$0
HF	inner tone light	+\$0
LU	soft white	+\$0
MT	medium tone	+\$0
SG	slate grey	+\$0
WL	sandstone	+\$0
WN	warm grey neutral	+\$0
CN	metallic champagne	+\$0
EH	metallic bronze	+\$0
MS	metallic silver	+\$0
CD	polished aluminum	+\$110

Step 4. Casters/Glides

20 casters +\$0
57 glides +\$0

Standing-Height Square Table

DT3BE.
DT3BS.
DT3BT.

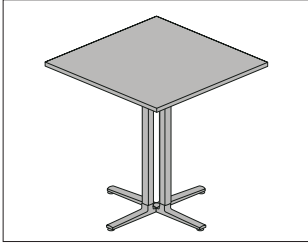

Everywhere™ Standing-Height Tables

Product Information

Description

This 42"-high, square table comes in multiple edge styles and has a laminate top with thermoplastic edge, laminate top with a thermoplastic backed plywood edge, veneer top and edge, or painted top and edge. The base has glides with 1/2" leveling range. Shipped knocked down.

Notes

For additional details on available edge options see Appendices.
For additional size, edge, and finish options, see Vary Easy Program in Appendices.

Dimensions

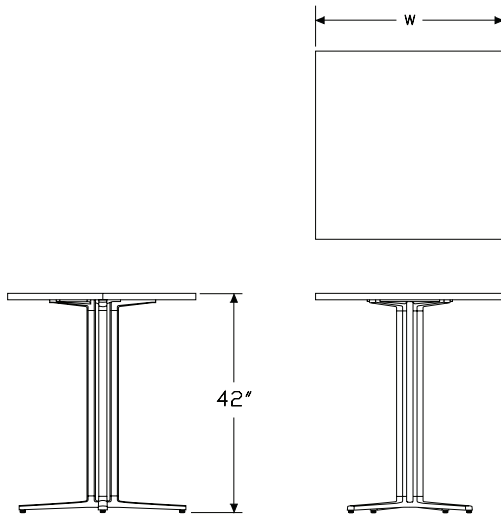

Specification Information

Step 1.

DT3B

Step 2. Edge

- S. squared-edge
- T. thin-edge
- E. eased-edge

Step 3. Depth/Width

- 3030** 30" deep x 30" wide
- 3636** 36" deep x 36" wide

Step 4. Surface Material

For squared-edge (S.)

- L laminate top/thermoplastic edge
- U laminate top/universal edge
- W veneer top/veneer edge **A**
- P painted Formcoat® top/edge

For thin-edge (T.)

- W veneer top/veneer edge **A**
- P painted Formcoat® top/edge

For eased-edge (E.)

- P painted Formcoat® top/edge

Step 5. Base Type

- X 4-column base

Prices for Steps 1-5.

	X
DT3BS. 3030 L	\$933
U	\$933
W	\$1108
P	\$1074
3636 L	\$1118
U	\$1118
W	\$1341
P	\$1288
	X
DT3BT. 3030 W	\$1330
P	\$1143
3636 W	\$1607
P	\$1371

Standing-Height Square Table

continued

	X
DT3BE. 3030 P	\$1143
3636 P	\$1371

Step 6.

Top Finish

For laminate top/thermoplastic edge (L) or laminate top/universal edge (U)

76	light brown walnut	+\$0
91	white	+\$0
98	studio white	+\$0
8Q	folkstone grey	+\$0
CL	cool grey neutral	+\$0
HF	inner tone light	+\$0
HM	natural maple	+\$0
HP	light anigre	+\$0
HT	inner tone	+\$0
HX	aged cherry	+\$0
HY	walnut on cherry	+\$0
LA	light ash	+\$0
LBA	clear on ash	+\$0
LBR	phantom ecru	+\$0
LBS	phantom cocoa	+\$0
LBU	medium matte walnut	+\$0
LBV	warm grey teak	+\$0
LBB	oak on ash	+\$0
LBC	walnut on ash	+\$0
LBD	dark brown walnut	+\$0
LBE	medium red walnut	+\$0
LBF	neutral twill	+\$0
LBG	sarum twill	+\$0
LBH	earthen twill	+\$0
LBJ	graphite twill	+\$0
LBK	pewter mesh	+\$0
LBL	steel mesh	+\$0
LBM	crisp linen	+\$0
LBN	classic linen	+\$0
LBP	casual linen	+\$0
LBQ	white twill	+\$0
LU	soft white	+\$0
WL	sandstone	+\$0
WN	warm grey neutral	+\$0

Top/Edge Finish: Wood Veneer

For veneer top/veneer edge (W)

2U	light brown walnut <input type="checkbox"/> A	+\$50
40	dark brown walnut <input type="checkbox"/> A	+\$50
ED	aged cherry <input type="checkbox"/> A	+\$50
EK	medium red walnut <input type="checkbox"/> A	+\$50
EW	medium matte walnut <input type="checkbox"/> A	+\$50
ET	clear on ash <input type="checkbox"/> A	+\$50
EU	oak on ash <input type="checkbox"/> A	+\$50
EV	walnut on ash <input type="checkbox"/> A	+\$50
UL	natural maple <input type="checkbox"/> A	+\$50
UX	walnut on cherry <input type="checkbox"/> A	+\$50

Top/Edge Finish: Opaque Formcoat®

For painted Formcoat® top/edge (P)

8Q	folkstone grey	+\$0
91	white	+\$0
CL	cool grey neutral	+\$0
LU	soft white	+\$0
WL	sandstone	+\$0
WN	warm grey neutral	+\$0

Everywhere™ Standing-Height Tables

Standing-Height Square Table

continued

Everywhere™ Standing-Height Tables

Step 7. Edge Finish

For laminate top/thermoplastic edge (L)

76	light brown walnut	+\$0
8Q	folkstone grey	+\$0
91	white	+\$0
98	studio white	+\$0
CL	cool grey neutral	+\$0
LA	light ash	+\$0
LBA	clear on ash	+\$0
LBR	phantom ecru	+\$0
LBS	phantom cocoa	+\$0
LBU	medium matte walnut	+\$0
LBV	warm grey teak	+\$0
LBB	oak on ash	+\$0
LBC	walnut on ash	+\$0
LBD	dark brown walnut	+\$0
LBE	medium red walnut	+\$0
LBF	neutral twill	+\$0
LBG	sarum twill	+\$0
LBH	earthen twill	+\$0
LBJ	graphite twill	+\$0
LBK	pewter mesh	+\$0
LBL	steel mesh	+\$0
LBM	crisp linen	+\$0
LBN	classic linen	+\$0
LBP	casual linen	+\$0
LBQ	white twill	+\$0
WL	sandstone	+\$0
WN	warm grey neutral	+\$0
HF	inner tone light	+\$0
HM	natural maple	+\$0
HP	light anigre	+\$0
HT	inner tone	+\$0
HX	aged cherry	+\$0
HY	walnut on cherry	+\$0
LU	soft white	+\$0

For laminate top/universal edge (U)

PLY	plywood edge	+\$50
------------	--------------	-------

Step 8. Base Finish

8Q	folkstone grey	+\$0
91	white	+\$0
98	studio white A	+\$0
BU	black umber	+\$0
CD	polished aluminum	+\$110
CL	cool grey neutral	+\$0
CN	metallic champagne	+\$0
EH	metallic bronze	+\$0
G2	graphite satin	+\$0
HF	inner tone light	+\$0
LU	soft white	+\$0
MS	metallic silver	+\$0
MT	medium tone	+\$0
SG	slate grey	+\$0
WL	sandstone	+\$0
WN	warm grey neutral	+\$0

Standing-Height Round Table

DT3CE.
DT3CS.
DT3CT.



Product Information

Description

This 42"-high, round table comes in multiple edge styles and has a laminate top with thermoplastic edge, veneer top and edge, or painted top and edge. The base has glides with 1/2" leveling range. Shipped knocked down.

Notes

For additional details on available edge options see Appendices.

For additional size, edge, and finish options, see Vary Easy Program in Appendices.

Dimensions

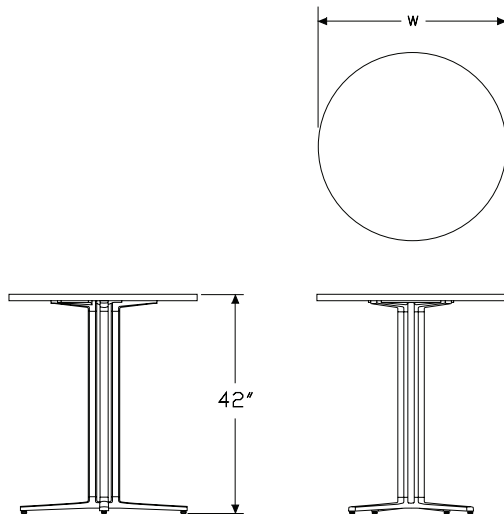

Specification Information

Step 1.

DT3C

Step 2. Edge

- S.** squared-edge
- T.** thin-edge
- E.** eased-edge

Step 3. Diameter

- 30** 30" diameter
- 36** 36" diameter

Step 4. Surface Material

For squared-edge (S.)

- L** laminate top/thermoplastic edge
- W** veneer top/veneer edge **A**
- P** painted Formcoat® top/edge

For thin-edge (T.)

- W** veneer top/veneer edge **A**
- P** painted Formcoat® top/edge

For eased-edge (E.)

- P** painted Formcoat® top/edge

Step 5. Base Type

- X** 4-column base

Prices for Steps 1-5.

	X
DT3CS. 30 L	\$1074
W	\$1273
P	\$1235
36 L	\$1287
W	\$1541
P	\$1481
	X
DT3CT. 30 W	\$1528
P	\$1314
36 W	\$1850
P	\$1575
	X
DT3CE. 30 P	\$1314

Standing-Height Round Table

continued

Everywhere™ Standing-Height Tables

36 P \$1575

Step 6.

Top Finish

For laminate top/thermoplastic edge (L)

76	light brown walnut	+\$0
91	white	+\$0
98	studio white	+\$0
8Q	folkstone grey	+\$0
CL	cool grey neutral	+\$0
HF	inner tone light	+\$0
HM	natural maple	+\$0
HP	light anigre	+\$0
HT	inner tone	+\$0
HX	aged cherry	+\$0
HY	walnut on cherry	+\$0
LA	light ash	+\$0
LBA	clear on ash	+\$0
LBR	phantom ecru	+\$0
LBS	phantom cocoa	+\$0
LBU	medium matte walnut	+\$0
LBV	warm grey teak	+\$0
LBB	oak on ash	+\$0
LBC	walnut on ash	+\$0
LBD	dark brown walnut	+\$0
LBE	medium red walnut	+\$0
LBF	neutral twill	+\$0
LBG	sarum twill	+\$0
LBH	earthen twill	+\$0
LBJ	graphite twill	+\$0
LBK	pewter mesh	+\$0
LBL	steel mesh	+\$0
LBM	crisp linen	+\$0
LBN	classic linen	+\$0
LBP	casual linen	+\$0
LBQ	white twill	+\$0
LU	soft white	+\$0
WL	sandstone	+\$0
WN	warm grey neutral	+\$0

Top/Edge Finish: Wood Veneer

For veneer top/veneer edge (W)

2U	light brown walnut A	+\$50
40	dark brown walnut A	+\$50
ED	aged cherry A	+\$50
EK	medium red walnut A	+\$50
EW	medium matte walnut A	+\$50
ET	clear on ash A	+\$50
EU	oak on ash A	+\$50
EV	walnut on ash A	+\$50
UL	natural maple A	+\$50
UX	walnut on cherry A	+\$50

Top/Edge Finish: Opaque Formcoat®

For painted Formcoat® top/edge (P)

8Q	folkstone grey	+\$0
91	white	+\$0
CL	cool grey neutral	+\$0
LU	soft white	+\$0
WL	sandstone	+\$0
WN	warm grey neutral	+\$0

Step 7. Edge Finish

For laminate top/thermoplastic edge (L)

76	light brown walnut	+\$0
8Q	folkstone grey	+\$0
91	white	+\$0
98	studio white	+\$0
CL	cool grey neutral	+\$0
LA	light ash	+\$0
LBA	clear on ash	+\$0
LBR	phantom ecru	+\$0
LBS	phantom cocoa	+\$0
LBU	medium matte walnut	+\$0
LBV	warm grey teak	+\$0
LBB	oak on ash	+\$0
LBC	walnut on ash	+\$0
LBD	dark brown walnut	+\$0
LBE	medium red walnut	+\$0
LBF	neutral twill	+\$0
LBG	sarum twill	+\$0
LBH	earthen twill	+\$0
LBJ	graphite twill	+\$0
LBK	pewter mesh	+\$0
LBL	steel mesh	+\$0
LBM	crisp linen	+\$0
LBN	classic linen	+\$0

Standing-Height Round Table

continued

LBP	casual linen	+\$0
LBQ	white twill	+\$0
WL	sandstone	+\$0
WN	warm grey neutral	+\$0
HF	inner tone light	+\$0
HM	natural maple	+\$0
HP	light anigre	+\$0
HT	inner tone	+\$0
HX	aged cherry	+\$0
HY	walnut on cherry	+\$0
LU	soft white	+\$0

Step 8. Base Finish

8Q	folkstone grey	+\$0
91	white	+\$0
98	studio white A	+\$0
BU	black umber	+\$0
CL	cool grey neutral	+\$0
G2	graphite satin	+\$0
HF	inner tone light	+\$0
LU	soft white	+\$0
MT	medium tone	+\$0
SG	slate grey	+\$0
WL	sandstone	+\$0
WN	warm grey neutral	+\$0
CN	metallic champagne	+\$0
EH	metallic bronze	+\$0
MS	metallic silver	+\$0
CD	polished aluminum	+\$110

Occasional Table, Square

DT4BS.
DT4BT.

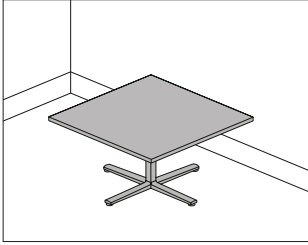

Product Information

Description

This 16"-high, square table comes in multiple edge styles and has a laminate top with thermoplastic edge, laminate top with a thermoplastic backed plywood edge, veneer top and edge, or painted top and edge. The base has glides with 1/2" leveling range. Shipped knocked down.

Notes

For additional details on available edge options see Appendices.
For additional size, edge, and finish options, see Vary Easy Program in Appendices.

Dimensions

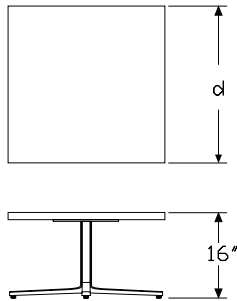

Everywhere™ Occasional Tables

Specification Information

Step 1.

DT4B

Step 2. Edge

- S. squared-edge
- T. thin-edge

Step 3. Depth/Width

- 2424 24" deep x 24" wide
- 3030 30" deep x 30" wide
- 3636 36" deep x 36" wide

Step 4. Surface Material

For squared-edge (S.)

- L laminate top/thermoplastic edge
- U laminate top/universal edge
- W veneer top/veneer edge A
- P painted Formcoat® top/edge

For thin-edge (T.)

- W veneer top/veneer edge A
- P painted Formcoat® top/edge

Step 5. Base Type

- S single-column base

Prices for Steps 1-5.

	S
DT4BS. 2424 L	\$712
U	\$712
W	\$832
P	\$820
3030 L	\$854
U	\$854
W	\$1008
P	\$983
3636 L	\$983
U	\$983
W	\$1168
P	\$1130
	S
DT4BT. 2424 W	\$998
P	\$873

Occasional Table, Square *continued*

3030 W	\$1211
P	\$1045
3636 W	\$1404
P	\$1203

Step 6.

Top Finish

For laminate top/thermoplastic edge (L) or laminate top/universal edge (U)

28	canyon	+\$0
29	misted	+\$0
38	twilight	+\$0
39	desert	+\$0
76	light brown walnut	+\$0
91	white	+\$0
98	studio white	+\$0
1X	vanilla	+\$0
2X	wheat	+\$0
3X	celery	+\$0
4X	coriander	+\$0
5X	chamomile	+\$0
6X	cinnamon	+\$0
7X	cardamom	+\$0
8X	kale	+\$0
8Q	folkstone grey	+\$0
CL	cool grey neutral	+\$0
HF	inner tone light	+\$0
HM	natural maple	+\$0
HP	light anigre	+\$0
HT	inner tone	+\$0
HX	aged cherry	+\$0
HY	walnut on cherry	+\$0
J4	frosted light grey	+\$0
LA	light ash	+\$0
LBA	clear on ash	+\$0
LBR	phantom ecru	+\$0
LBS	phantom cocoa	+\$0
LBU	medium matte walnut	+\$0
LBV	warm grey teak	+\$0
LBB	oak on ash	+\$0
LBC	walnut on ash	+\$0
LBD	dark brown walnut	+\$0
LBE	medium red walnut	+\$0
LBF	neutral twill	+\$0
LBG	sarum twill	+\$0
LBH	earthen twill	+\$0

LBJ	graphite twill	+\$0
LBK	pewter mesh	+\$0
LBL	steel mesh	+\$0
LBM	crisp linen	+\$0
LBN	classic linen	+\$0
LBP	casual linen	+\$0
LBQ	white twill	+\$0
LG	light grey (discontinuing)	+\$0
LM	mahogany	+\$0
LT	light tone	+\$0
LU	soft white	+\$0
MT	medium tone	+\$0
OG	honey maple	+\$0
WL	sandstone	+\$0
WN	warm grey neutral	+\$0
X1	chalk white	+\$0

Top/Edge Finish: Wood Veneer

For veneer top/veneer edge (W)

2U	light brown walnut <input type="checkbox"/> A	+\$50
40	dark brown walnut <input type="checkbox"/> A	+\$50
ED	aged cherry <input type="checkbox"/> A	+\$50
EK	medium red walnut <input type="checkbox"/> A	+\$50
EW	medium matte walnut <input type="checkbox"/> A	+\$50
ET	clear on ash <input type="checkbox"/> A	+\$50
EU	oak on ash <input type="checkbox"/> A	+\$50
EV	walnut on ash <input type="checkbox"/> A	+\$50
UL	natural maple <input type="checkbox"/> A	+\$50
UX	walnut on cherry <input type="checkbox"/> A	+\$50

Top/Edge Finish: Opaque Formcoat®

For painted Formcoat® top/edge (P)

8Q	folkstone grey	+\$0
91	white	+\$0
CL	cool grey neutral	+\$0
LU	soft white	+\$0
WL	sandstone	+\$0
WN	warm grey neutral	+\$0

Occasional Table, Square *continued*

Everywhere™ Occasional Tables

Step 7. Edge Finish

For laminate top/thermoplastic edge (L)

76	light brown walnut	+\$0
8Q	folkstone grey	+\$0
91	white	+\$0
98	studio white	+\$0
CL	cool grey neutral	+\$0
HF	inner tone light	+\$0
HM	natural maple	+\$0
HP	light anigre	+\$0
HT	inner tone	+\$0
HX	aged cherry	+\$0
HY	walnut on cherry	+\$0
LA	light ash	+\$0
LBA	clear on ash	+\$0
LBB	oak on ash	+\$0
LBC	walnut on ash	+\$0
LBD	dark brown walnut	+\$0
LBE	medium red walnut	+\$0
LBF	neutral twill	+\$0
LBG	sarum twill	+\$0
LBH	earthen twill	+\$0
LBJ	graphite twill	+\$0
LBK	pewter mesh	+\$0
LBL	steel mesh	+\$0
LBM	crisp linen	+\$0
LBN	classic linen	+\$0
LBP	casual linen	+\$0
LBQ	white twill	+\$0
LBR	phantom ecru	+\$0
LBS	phantom cocoa	+\$0
LBU	medium matte walnut	+\$0
LBV	warm grey teak	+\$0
LU	soft white	+\$0
WL	sandstone	+\$0
WN	warm grey neutral	+\$0

For laminate top/universal edge (U)

PLY	plywood edge	+\$50
------------	--------------	-------

Step 8. Base Finish

8Q	folkstone grey	+\$0
91	white	+\$0
98	studio white A	+\$0
BU	black umber	+\$0
CD	polished aluminum	+\$110
CL	cool grey neutral	+\$0
CN	metallic champagne	+\$0
EH	metallic bronze	+\$0
G2	graphite satin	+\$0
HF	inner tone light	+\$0
LU	soft white	+\$0
MS	metallic silver	+\$0
MT	medium tone	+\$0
SG	slate grey	+\$0
WL	sandstone	+\$0
WN	warm grey neutral	+\$0

Occasional Table, Round

DT4CS.
DT4CT.

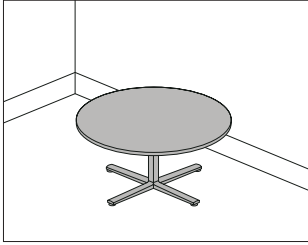

Product Information

Description

This 16"-high, round table comes in multiple edge styles and has a laminate top with thermoplastic edge, veneer top and edge, or painted top and edge. The base has glides with 1/2" leveling range. Shipped knocked down.

Notes

For additional details on available edge options see Appendices.

For additional size, edge, and finish options, see Vary Easy Program in Appendices.

Dimensions

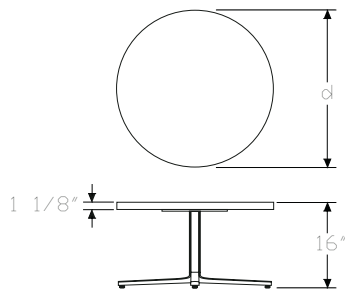

Specification Information

Step 1.

DT4C

Step 2. Edge

- S.** squared-edge
- T.** thin-edge

Step 3. Diameter

- 30** 30" diameter
- 36** 36" diameter

Step 4. Surface Material

For squared-edge (S.)

- L** laminate top/thermoplastic edge
- W** veneer top/veneer edge **A**
- P** painted Formcoat® top/edge

For thin-edge (T.)

- W** veneer top/veneer edge **A**
- P** painted Formcoat® top/edge

Step 5. Base Type

- S** single-column base

Prices for Steps 1-5.

	S
DT4CS. 30 L	\$981
W	\$1160
P	\$1129
36 L	\$1129
W	\$1344
P	\$1299
	S
DT4CT. 30 W	\$1391
P	\$1202
36 W	\$1613
P	\$1383

Step 6.

Top Finish

For laminate top/thermoplastic edge (L)

- 28** canyon +\$0
- 29** misted +\$0

Occasional Table, Round *continued*

LBG	sarum twill	+\$0
LBH	earthen twill	+\$0
LBJ	graphite twill	+\$0
LBK	pewter mesh	+\$0
LBL	steel mesh	+\$0
LBM	crisp linen	+\$0
LBN	classic linen	+\$0
LBP	casual linen	+\$0
LBQ	white twill	+\$0
LBR	phantom ecru	+\$0
LBS	phantom cocoa	+\$0
LBU	medium matte walnut	+\$0
LBV	warm grey teak	+\$0
LU	soft white	+\$0
WL	sandstone	+\$0
WN	warm grey neutral	+\$0

Step 8. Base Finish

8Q	folkstone grey	+\$0
91	white	+\$0
98	studio white <input type="checkbox"/> A	+\$0
BU	black umber	+\$0
CL	cool grey neutral	+\$0
G2	graphite satin	+\$0
HF	inner tone light	+\$0
LU	soft white	+\$0
MT	medium tone	+\$0
SG	slate grey	+\$0
WL	sandstone	+\$0
WN	warm grey neutral	+\$0
CN	metallic champagne	+\$0
EH	metallic bronze	+\$0
MS	metallic silver	+\$0
CD	polished aluminum	+\$110

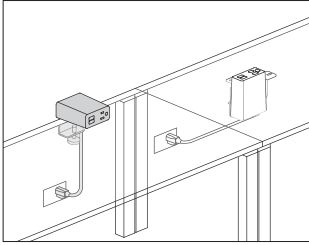

Product Information

Description

This electrical distributor plugs directly into floor, wall, or ceiling drop outlets. Each module configuration presents the same visual appearance. Cable clips and attachment hardware included. Product is UL listed.

Notes

- Cable clips for cord management are intended for a 1-time installation.
- Clamp versions can be reoriented in the field by a technician.
- A small LED light illuminates through the USB ports when the USB version is plugged in and powered.
- USB ports provide 10-watt power to charge most devices and tablets at full speed.
- Cord color is predetermined. For white (G1) finish cords will be white. For graphite (G1) finish cords will be black.
- Grommet mount attachment (Y1414.xxxG) does not come with the mini grommet. Order Logic mini grommet (Y1412.) separately, as needed.

Everywhere™ Power and Data Support

Dimensions

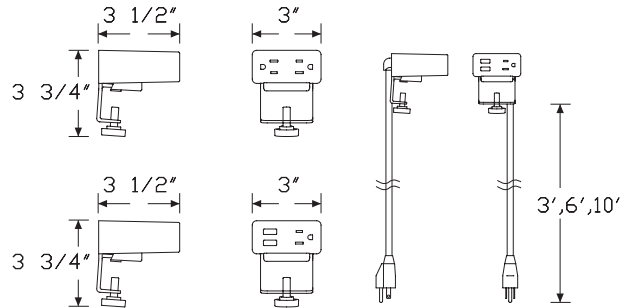

Surface Clamp

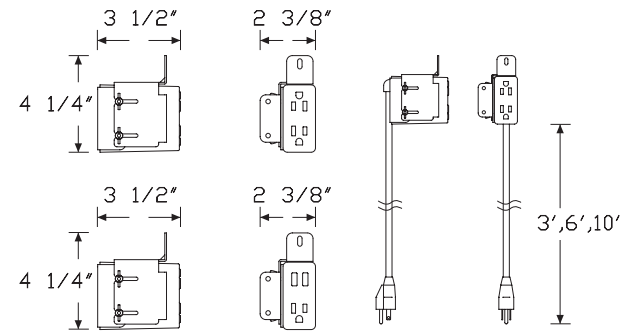

Grommet Mount

Specification Information

Step 1.

Y1414.

Step 2. Configuration

J 1 simplex receptacles, 2 powered USB

K 2 simplex receptacles

Step 3. Cord/Conduit Length

03 3' cord/conduit

06 6' cord/conduit

10 10' cord/conduit

Step 4. Attachment

G grommet mount

S surface clamp

Prices for Steps 1-4.

		G	S
Y1414. J	03	\$342	342
	06	\$342	342
	10	\$352	352
	K 03	\$191	191
	06	\$191	191
	10	\$201	201

Step 5. Finish

91 white +\$0

98 studio white +\$0

G1 graphite +\$0

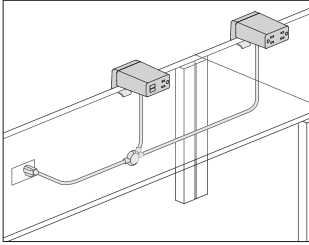

Product Information

Description

This electrical distributor plugs directly into floor, wall, or ceiling drop outlets. Each module configuration presents the same visual appearance. Cable clips and attachment hardware included. Product is ETL listed to UL962.

Notes

- Cable clips for cord management are intended for a 1-time installation.
- Clamp versions can be reoriented in the field by a technician.
- Jumper length denotes distance between center points of each split point.
- Cord length denotes distance from plug end to first split point.
- All branch lengths from main power cord to module are 12".
- A small LED light illuminates through the USB ports when the USB version is plugged in and powered.
- USB ports provide 10-watt power to charge most devices and tablets at full speed.
- The cord head contains a circuit breaker when there are more than 3 simplex receptacles.
- Grommet mount attachment (Y1415.xxxG) does not come with the mini grommet. Order Logic mini grommet (Y1412.) separately, as needed.

Everywhere™ Power and Data Support

Dimensions

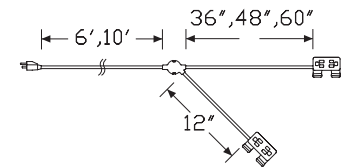
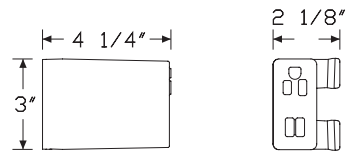

Two Power Modules

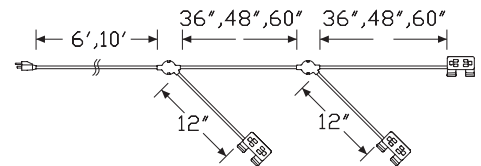

Three Power Modules

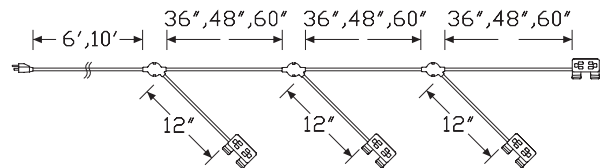

Four Power Modules

Specification Information

Step 1.

Y1415. A

Step 2. Number of Modules

- 2** two power modules A
- 3** three power modules A
- 4** four power modules A

Step 3. Power Type

- J** 1 simplex receptacles, 2 powered USB, all modules A
- K** 2 simplex receptacles, all modules A
- L** first module has 1 AC plus 2 powered USB all other modules have all AC simplex A

Step 4. Jumper Length

- 36** 36" between split points A
- 48** 48" between split points A
- 60** 60" between split points A

Step 5. Attachment

- G** grommet mount A
- S** surface clamp A

Step 6. Cord/Conduit Length

- 06** 6' cord/conduit A
- 10** 10' cord/conduit A

Prices for Steps 1-6.

		36G06	36G10	36S06	36S10	48G06	48G10
Y1415. 2	J	\$758	768	758	768	766	777
	K	\$454	465	454	465	462	473
	L	\$606	617	606	617	615	625
3	J	\$1129	1139	1129	1139	1145	1156
	K	\$689	700	689	700	707	717
	L	\$842	852	842	852	858	869
4	J	\$1533	1544	1533	1544	1558	1569
	K	\$925	935	925	935	951	961
	L	\$1077	1088	1077	1088	1102	1112
		48S06	48S10	60G06	60G10	60S06	60S10
Y1415. 2	J	\$766	777	775	786	775	786
	K	\$462	473	471	481	471	481
	L	\$615	625	623	633	623	633
3	J	\$1145	1156	1163	1173	1163	1173
	K	\$707	717	723	733	723	733
	L	\$858	869	876	886	876	886

4 J	\$1558	1569	1594	1605	1594	1605
K	\$951	961	975	986	975	986
L	\$1102	1112	1128	1138	1128	1138

Step 7. Finish

- 91** white A +\$0
- 98** studio white A +\$0
- G1** graphite A +\$0

Logic C1000 Universal Clamp Mount Distributor

Y1423.

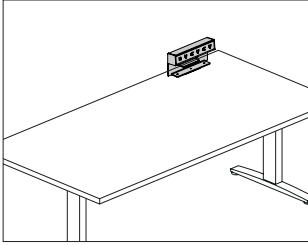

Product Information

Description

This Logic Power Access Solutions™ clamp mounted electrical distributor comes in several widths and configurations of simplex receptacles and USB charging ports. The unit is powered using a standard power cord with plug end or a hard-wired connection with electrical conduit. Data cords can be routed through the integrated opening at the rear of the unit. Product is UL listed.

Notes

Clamp mounts on worksurfaces 1"-1 1/4" thick.

Faceplate color matches unit color.

Simplex receptacles have alternating orientation and greater than normal plug spacing to accommodate most plug types.

USB ports supply 10-watt power and will charge most small electronic devices. Software in each device controls that devices ability to accept a charge via USB.

Everywhere™ Power and Data Support

Dimensions



2 simplex receptacles, 2 powered USB

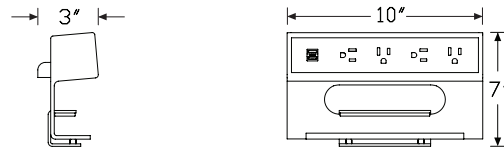

4 simplex receptacles, 2 powered USB

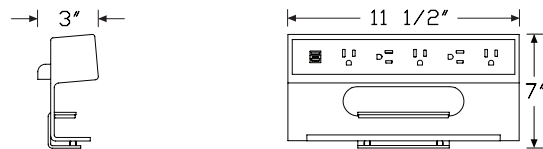

5 simplex receptacles, 2 powered USB



3 simplex receptacles

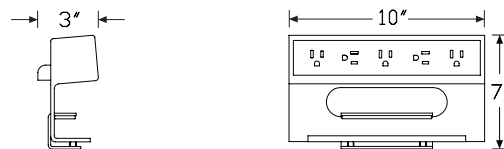

5 simplex receptacles

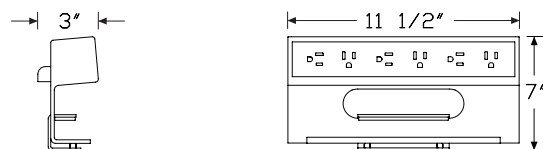

6 simplex receptacles

Logic C1000 Universal Clamp Mount Distributor *continued*

Specification Information

Step 1.

Y1423. A

Step 2. Configuration

- A** 2 simplex receptacles, 2 powered USB A
- C** 4 simplex receptacles, 2 powered USB A
- D** 5 simplex receptacles, 2 powered USB A
- E** 3 simplex receptacles A
- F** 5 simplex receptacles A
- G** 6 simplex receptacles A

Step 3. Power Type

- A** power cord with plug end A
- B** conduit with open end, for hard-wiring A

Step 4. Cord/Conduit Length

- 03** 3' cord/conduit A
- 06** 6' cord/conduit A
- 10** 10' cord/conduit A

Prices for Steps 1-4.

		03	06	10
Y1423. A	A	\$462	462	473
	B	\$513	513	523
C	A	\$555	555	565
	B	\$606	606	617
D	A	\$594	594	605
	B	\$645	645	656
E	A	\$310	310	321
	B	\$362	362	372
F	A	\$404	404	414
	B	\$454	454	465
G	A	\$442	442	453
	B	\$493	493	504

Step 5. Finish

- 91** white A +\$0
- 98** studio white A +\$0
- G1** graphite A +\$0
- MS** metallic silver A +\$0

Logic G1000 Grommet Mounted Electrical Distributor Y1425.

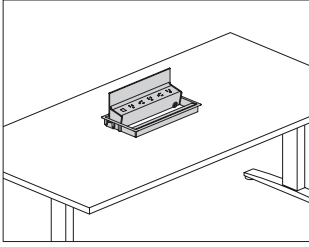

Product Information

Description

This Logic Power Access Solutions™ grommet mounted electrical distributor comes in several widths and configurations of simplex receptacles and USB charging ports. The unit is powered using a standard power cord with plug end, a hard-wired connection with electrical conduit, or an IEC connector when used with Renew™ Sit-to-Stand tables. An integrated cord keeper at the face of the unit captures data cords. The unit pivots from a closed position to 135° allowing easy access to power and data cords stored beneath the unit. Product is UL listed.

Notes

Field cutting of grommet cutout is possible.

IEC connector for Renew power type (C) includes short cord designed to connect to the Renew table power cord through-leg option. Actual cord length may vary.

Simplex receptacles have alternating orientation and greater than normal plug spacing to accommodate most plug types.

USB ports supply 10-watt power and will charge most small electronic devices. Software in each device controls that devices ability to accept a charge via USB.

Refer to Renew™ Sit-to-Stand Tables and Locale® planning guides for specific application information.

20' cord/conduit length (20) is recommended for Exclave® applications.

Everywhere™ Power and Data Support

Dimensions

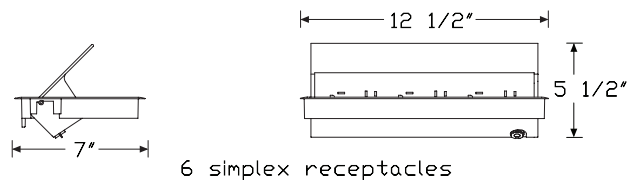
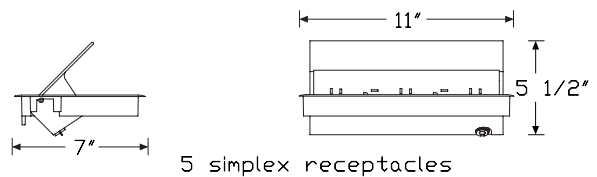
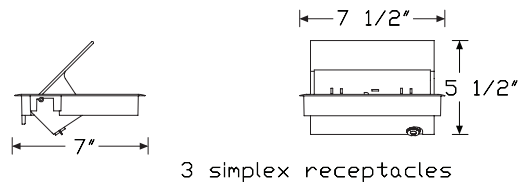
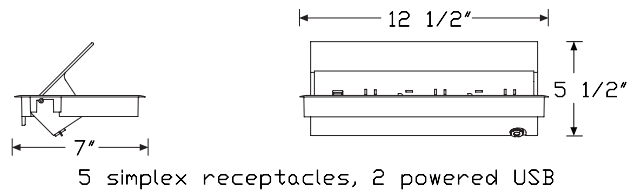
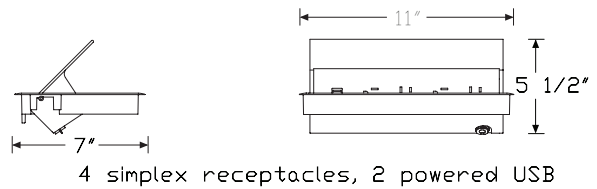
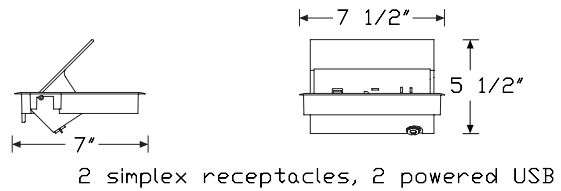

Logic G1000 Grommet Mounted Electrical Distributor *continued*

Specification Information

Step 1.

Y1425. A

Step 2. Configuration

- A** 2 simplex receptacles, 2 powered USB A
- C** 4 simplex receptacles, 2 powered USB A
- D** 5 simplex receptacles, 2 powered USB A
- E** 3 simplex receptacles A
- F** 5 simplex receptacles A
- G** 6 simplex receptacles A

Step 3. Power Type

- A** power cord with plug end A
- B** conduit with open end, for hard-wiring A
- C** IEC connector for Renew Tables A

Step 4. Cord/Conduit Length

For power cord with plug end (A)

- 03** 3' cord/conduit A
- 06** 6' cord/conduit A
- 10** 10' cord/conduit A
- 20** 20' cord/conduit A

For conduit with open end, for hard-wiring (B)

- 03** 3' cord/conduit A
- 06** 6' cord/conduit A
- 10** 10' cord/conduit A

For IEC connector for Renew Tables (C)

- 03** 3' cord/conduit A

Prices for Steps 1-4.

		03	06	10	20
Y1425. A	A	\$658	658	668	679
	B	\$709	709	719	—
	C	\$668	—	—	—
C	A	\$763	763	774	785
	B	\$814	814	825	—
	C	\$774	—	—	—
D	A	\$831	831	842	852
	B	\$882	882	892	—
	C	\$842	—	—	—
E	A	\$506	506	516	526
	B	\$556	556	567	—
	C	\$516	—	—	—

F	A	\$611	611	622	632
	B	\$662	662	673	—
	C	\$622	—	—	—
G	A	\$679	679	689	700
	B	\$729	729	741	—
	C	\$689	—	—	—

Step 5. Finish

- 91** white A +\$0
- 98** studio white A +\$0
- G1** graphite A +\$0
- MS** metallic silver A +\$0

Everywhere™ Power and Data Support

Logic Mini Grommet

Y1412.

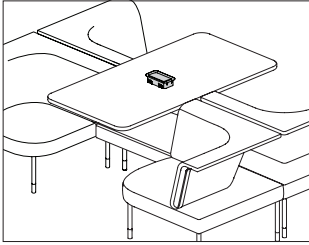

Product Information

Description

This Logic Power Access Solutions™ plastic grommet is available in mini rectangle or mini square configuration. The integrated flaps can hide the things below the surface while also retaining power and data cords.

Notes

This grommet is installed in some HermanMiller applications. Verify your application before ordering grommet separately.

Dimensions

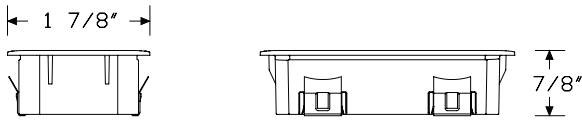
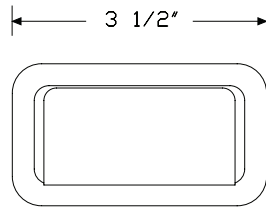

Grommet - Rectangle

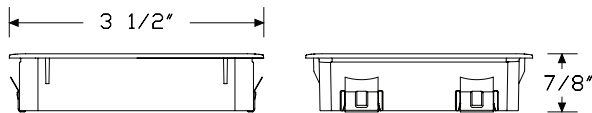
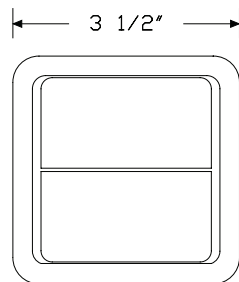

Grommet - Square

Specification Information

Step 1.

Y1412.

Step 2. Configuration

- 1 mini rectangle grommet
- 2 mini square grommet

Prices for Steps 1-2.

Y1412. 1	\$27
2	\$31

Step 3. Finish

91	white	+\$0
98	studio white	+\$0
G1	graphite	+\$0

Logic G1200 Grommet Pass Thru Y1420.

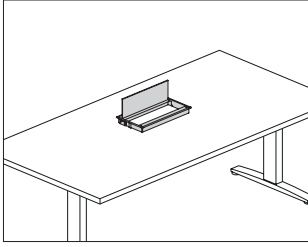

Product Information

Description

This Logic Power Access Solutions™ grommet mounted metal enclosure provides access to cords kept beneath the surface. The unit has an integrated cord keeper.

Notes

Unit size is based on the grommet mounted electrical distributor (Y1425.) with simplex receptacles.

Dimensions

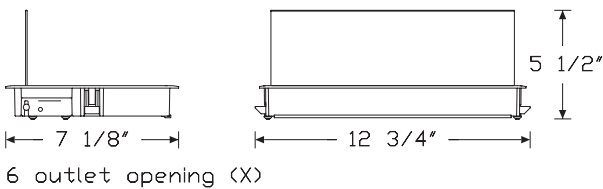
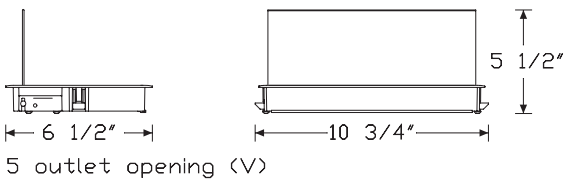
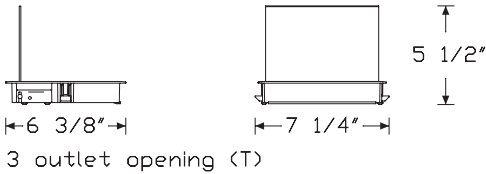

Specification Information

Step 1.

Y1420. [A]

Step 2. Configuration

- T** three outlet opening [A]
- V** five outlet opening [A]
- X** six outlet opening [A]

Prices for Steps 1-2.

Y1420. T	\$220
V	\$242
X	\$263

Step 3. Finish

91 white [A]	+\$0
98 studio white [A]	+\$0
G1 graphite [A]	+\$0
MS metallic silver [A]	+\$0

Everywhere™ Power and Data Support

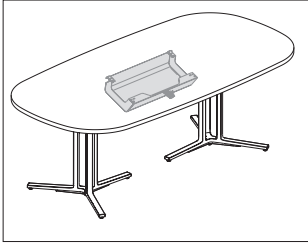

Product Information

Description

This stand-alone painted steel cable management tray mounts to the underside of most conference table surfaces. It can be used with an in-surface grommet mounted unit, providing cord storage under the surface. The tray drops down for access to cords and can be easily stowed back in place.

Notes

Trough widths are optimized to fit on 60", 72", or 84"-wide tables.

Actual trough widths are:

Table Width—Trough Width

- 60"—24"
- 72"—30"
- 84"—42"

Dimensions

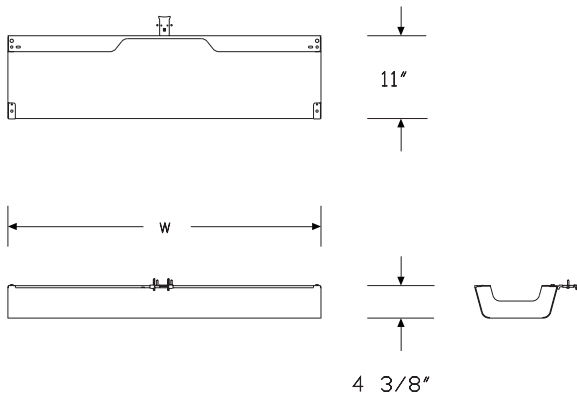

Specification Information

Step 1.

DT9C.

Step 2. Table Width

- 60** 60" wide
- 72** 72" wide
- 84** 84" wide

Prices for Steps 1-2.

DT9C. 60	\$299
72	\$299
84	\$299

Step 3. Finish

8Q	folkstone grey	+\$0
91	white	+\$0
98	studio white	+\$0
BU	black umber	+\$0
CL	cool grey neutral	+\$0
CN	metallic champagne	+\$0
EH	metallic bronze	+\$0
G2	graphite satin	+\$0
HF	inner tone light	+\$0
LU	soft white	+\$0
MS	metallic silver	+\$0
MT	medium tone	+\$0
SG	slate grey	+\$0
WL	sandstone	+\$0
WN	warm grey neutral	+\$0

Logic HD Cable Manager

Y1424.

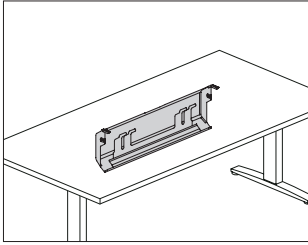

Product Information

Description

This Logic Power Access Solutions™ stand-alone cable management tray mounts to the underside of most surfaces. It can be used with a Logic unit for cord storage, or used alone with cords routed through the back side of the unit. Tray drops down and holds cords in place while working and can be easily stowed back in place.

Dimensions

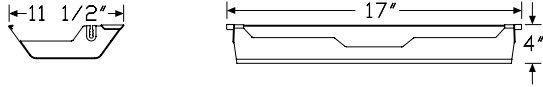

Specification Information

Step 1.

Y1424. [A]

Step 2. Size

17 17" wide tray [A]

Prices for Steps 1-2.

Y1424. 17 \$242

Step 3. Finish

- 91** white [A] +\$0
- 98** studio white [A] +\$0
- G1** graphite [A] +\$0
- MS** metallic silver [A] +\$0

Everywhere™ Power and Data Support

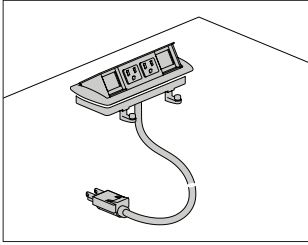

Product Information

Description

This electrical distributor mounts flush in a surface and has a one-touch pop-up mechanism for accessing power and data. It has 2 simplex receptacles and 2 data openings, and is available with a power cord with plug end, or electrical conduit for hardwire connection. A voice/data adapter kit is included, allowing the data openings to accept various manufacturers' couplers and jacks. Attachment hardware and cord/cable clips are also included. Product is UL listed.

Notes

Field cutting of surface may be required. Information on surface cutout size is included on instruction sheet.

Distributor with PVC-free wiring option (LZ) is Cradle to Cradle Silver Certified.

Dimensions

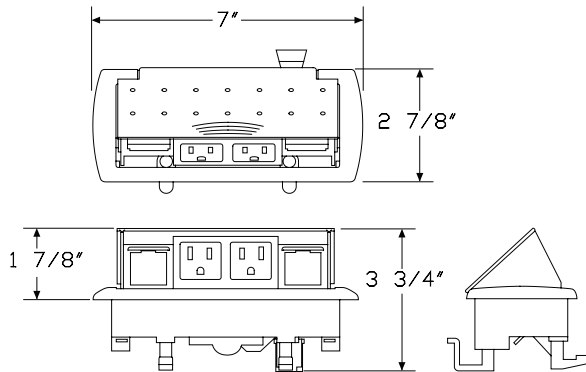

Everywhere™ Power and Data Support

Specification Information

Step 1.

Y1321.

Step 2. Power Type

- A** power cord with plug end
- B** conduit with open end, for hard-wiring

Step 3. Cord/Conduit Length

- 03** 3' cord/conduit
- 06** 6' cord/conduit
- 10** 10' cord/conduit
- 20** 20' cord/conduit

Prices for Steps 1-3.

	03	06	10	20
Y1321. A	\$205	205	214	263
B	\$259	259	268	317

Step 4. Wiring Type

- 4Z** standard +\$0
- LZ** PVC-free +\$39

Step 5. Finish

- 0H** black +\$0

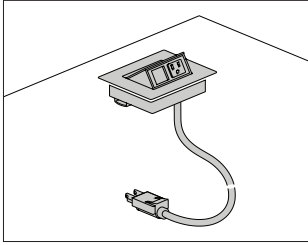

Product Information

Description

This electrical distributor mounts flush in a surface and has a one-touch pop-up mechanism for accessing power and data. It can be configured with 2 simplex receptacles, or 1 simplex receptacle and 1 data opening. The distributor is available with a power cord with plug end, or electrical conduit for hardwire connection. A voice/data adapter kit is included, allowing the data openings to accept various manufacturers' couplers and jacks. Attachment hardware and cord/cable clips are also included. Product is UL listed.

Notes

Field cutting of surface may be required. Information on surface cutout size is included on instruction sheet.

Distributor with PVC-free wiring option (LZ) is Cradle to Cradle Silver Certified.

Distributor with silver finish option (oI) or white finish option (oJ) and standard wiring (4Z) has painted metal trim with white plastic simplex/data interior. Distributor with black finish option (oH) and standard wiring (4Z) has black painted trim with black plastic simplex/data interior. Distributor with PVC-free wiring option (LZ) has black plastic simplex/data interior, regardless of the finish color.

Dimensions

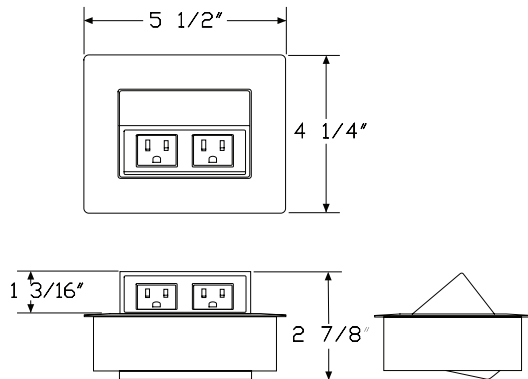

Specification Information

Step 1.

Y1322.

Step 2. Configuration

- 1 1 simplex receptacle, 1 data opening
- 2 2 simplex receptacles

Step 3. Power Type

- A power cord with plug end
- B conduit with open end, for hard-wiring

Step 4. Cord/Conduit Length

- 03 3' cord/conduit
- 06 6' cord/conduit
- 10 10' cord/conduit
- 20 20' cord/conduit

Prices for Steps 1-4.

		03	06	10	20
Y1322. 1	A	\$244	244	253	302
	B	\$297	297	306	353
	2 A	\$259	259	268	317
	B	\$311	311	322	371

Step 5. Wiring Type

- 4Z standard +\$0
- LZ PVC-free +\$39

Step 6. Finish

- oH black +\$0
- oI silver +\$0
- oJ white +\$0

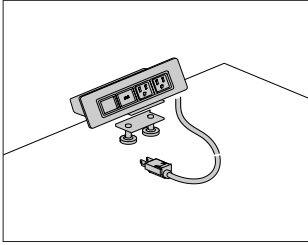

Product Information

Description
 This electrical distributor can grommet-mount flush in a surface, or clamp-mount to the edge. It can be configured with several combinations of simplex receptacles, data openings, and USB charging ports. The distributor is available with a power cord with plug end, or electrical conduit for hardwire connection. A voice/data adapter kit is included, allowing the data openings to accept various manufacturers' couplers and jacks. Attachment hardware and cord/cable clips are also included. Product is UL listed.

Notes

Field cutting of surface may be required. Information on surface cutout size is included on instruction sheet.
 Silver option (oI) and white option (oJ) have painted metal trim with white plastic simplex/data interiors. Black option (oH) has black painted trim with black plastic simplex/data interior.
 Overall width for distributor with 4 openings is 8" wide. Overall width for distributor with 6 openings is 11" wide.
 USB port charges at 2.1 amps.

Dimensions

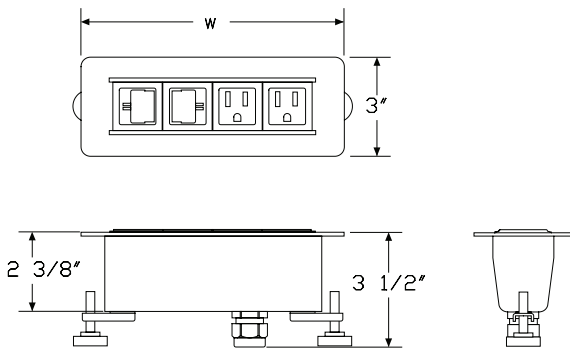

Specification Information

Step 1.

Y1323.

Step 2. Configuration

- 3** 2 simplex receptacles, 2 data openings
- 4** 3 simplex receptacles, 3 data openings
- 5** 2 simplex receptacles, 1 data opening, 1 charging USB port
- 6** 3 simplex receptacles, 2 data opening, 1 charging USB port

Step 3. Power Type

- A** power cord with plug end
- B** conduit with open end, for hard-wiring

Step 4. Cord/Conduit Length

- 03** 3' cord/conduit
- 06** 6' cord/conduit
- 10** 10' cord/conduit
- 20** 20' cord/conduit

Step 5. Attachment

- G** grommet mount
- S** surface clamp

Prices for Steps 1-5.

		03G	03S	06G	06S	10G	10S	
Y1323. 3	A	\$279	279	279	279	288	288	
	B	\$332	332	332	332	341	341	
4	A	\$347	347	347	347	356	356	
	B	\$402	402	402	402	412	412	
5	A	\$390	390	390	390	400	400	
	B	\$444	444	444	444	453	453	
6	A	\$459	459	459	459	469	469	
	B	\$513	513	513	513	523	523	
							20G	20S
Y1323. 3	A						\$337	337
	B						\$388	388
4	A						\$407	407
	B						\$459	459
5	A						\$449	449
	B						\$521	521
6	A						\$517	517
	B						\$592	592

Step 6. Finish		
OH	black	+\$0
OI	silver	+\$0
OJ	white	+\$0

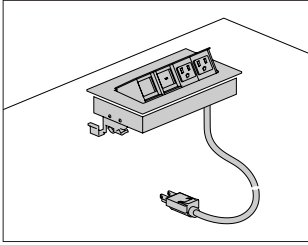

Product Information

Description

This electrical distributor mounts flush in a surface and has a one-touch pop-up mechanism for accessing power and data. It can be configured with several combinations of simplex receptacles, data openings, and USB charging ports. The distributor is available with a power cord with plug end, or electrical conduit for hardwire connection. A voice/data adapter kit is included, allowing the data openings to accept various manufacturers' couplers and jacks. Attachment hardware and cord/cable clips are also included. Product is UL listed.

Notes

Field cutting of surface may be required. Information on surface cutout size is included on instruction sheet.

Distributor with PVC-free wiring option (LZ) is Cradle to Cradle Silver Certified.

Distributor with silver anodized finish option (oK) and standard wiring (4Z) has anodized trim with white plastic simplex/data interior.

Distributor with silver anodized finish option (oK) and PVC-free wiring (LZ) has anodized trim with black plastic simplex/data interior.

Overall width for distributor with openings is 8 3/4" wide. Overall width for distributor with 7 openings is 12 3/4" wide.

USB port charges at 2.1 amps.

Dimensions

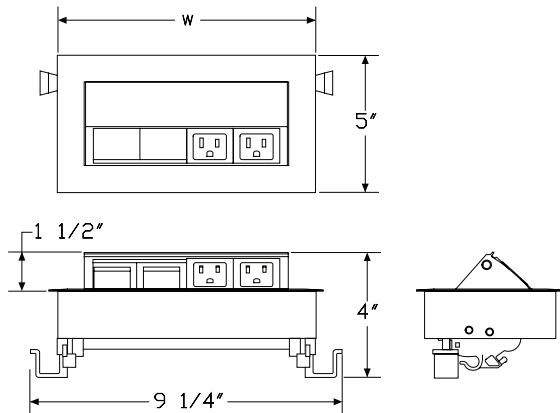

Specification Information

Step 1.

Y1324.

Step 2. Configuration

3	2 simplex receptacles, 2 data openings
5	3 simplex receptacles, 4 data openings
6	2 simplex receptacles, 1 data opening, 1 charging USB port
7	3 simplex receptacles, 3 data opening, 1 charging USB port
8	3 simplex receptacles, 2 data opening, 2 charging USB ports

Step 3. Power Type

A	power cord with plug end
B	conduit with open end, for hard-wiring

Step 4. Cord/Conduit Length

03	3' cord/conduit
06	6' cord/conduit
10	10' cord/conduit
20	20' cord/conduit

Prices for Steps 1-4.

		03	06	10	20
Y1324. 3	A	\$388	388	398	447
	B	\$442	442	453	501
5	A	\$500	500	510	557
	B	\$553	553	559	607
6	A	\$501	501	510	557
	B	\$554	554	564	613
7	A	\$611	611	621	670
	B	\$665	665	672	719
8	A	\$723	723	732	782
	B	\$777	777	784	831

Step 5. Wiring Type

4Z	standard	+\$0
LZ	PVC-free	+\$39

Step 6. Finish

OK	silver anodized	+\$0
-----------	-----------------	------

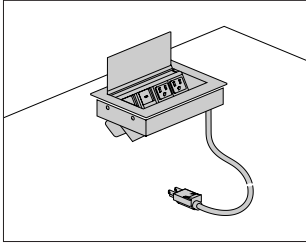

Product Information

Description

This electrical distributor mounts flush in a surface and has a flip-up lid for accessing power and data from above or below the surface. The flip lid can be closed once devices are connected for a clean visual appearance. It can be configured with several combinations of simplex receptacles, data openings, and USB charging ports. The distributor is available with a power cord with plug end, or electrical conduit for hardwire connection. A voice/data adapter kit is included, allowing the data openings to accept various manufacturers' couplers and jacks. Attachment hardware and cord/cable clips are also included. Product is UL listed.

Notes

Field cutting of surface may be required. Information on surface cutout size is included on instruction sheet.

Silver anodized option (oK) has anodized trim with white plastic simplex/data interior.

Overall width for distributor with 4 openings is 8³/₈" wide. Overall width for distributor with 6 openings is 11³/₈" wide.

USB port charges at 2.1 amps.

Dimensions

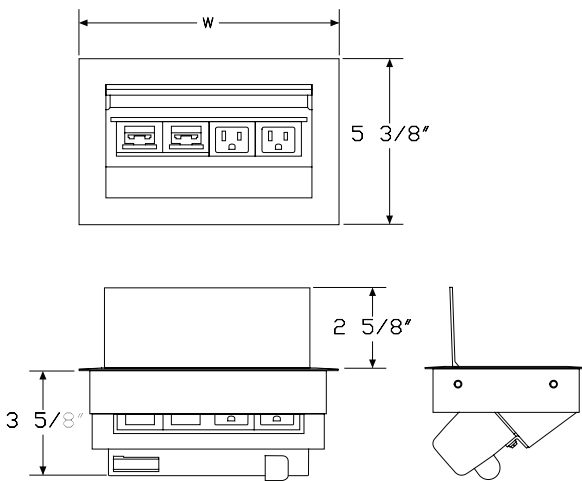

Specification Information

Step 1.

Y1325.

Step 2. Configuration

3	2 simplex receptacles, 2 data openings
7	3 simplex receptacles, 3 data openings
5	2 simplex receptacles, 1 data opening, 1 charging USB port
6	3 simplex receptacles, 2 data opening, 1 charging USB port

Step 3. Power Type

A	power cord with plug end
B	conduit with open end, for hard-wiring

Step 4. Cord/Conduit Length

03	3' cord/conduit
06	6' cord/conduit
10	10' cord/conduit
20	20' cord/conduit

Prices for Steps 1-4.

		03	06	10	20
Y1325. 3	A	\$458	458	468	516
	B	\$512	512	521	569
7	A	\$526	526	538	586
	B	\$580	580	591	639
5	A	\$571	571	580	628
	B	\$624	624	633	681
6	A	\$639	639	649	698
	B	\$691	691	705	751

Step 5. Finish

OK	silver anodized				+\$0
-----------	-----------------	--	--	--	------

Cable Management Clip

DT9A.

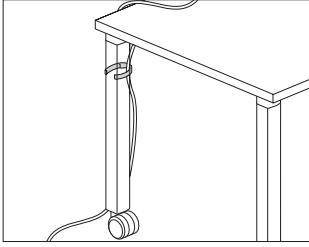

Product Information

Description
This plastic clip snaps onto an Everywhere™ table leg to route cables or cords. Finish is clear. Package of 10.

Dimensions

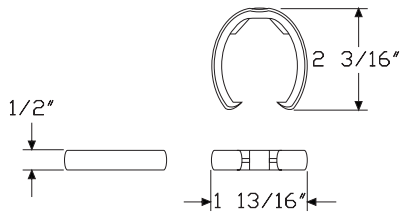

Specification Information

Step 1.
DT9A. \$37

Vertical Cord Covers

DT9B.

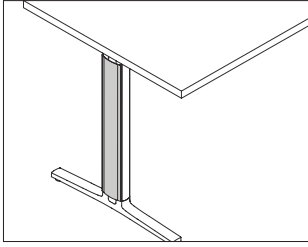

Product Information

Description

These cord covers attach to Everywhere™ table T-leg and Y-leg sections that have either casters or glides. The covers are field installed, and are easily removed and reinstalled for ease of cable management.

Notes

The T cover works with both the (T) and (C) base options.

The Y cover works with both the (E) and (G) base options.

To ensure proper height of the covers, select (C) if your table has casters or select (G) if your table has glides.

Dimensions

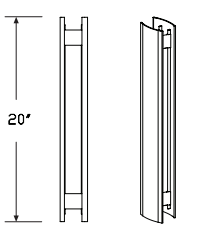

T-leg with casters

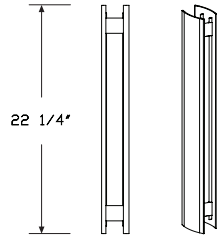

T-leg with glides

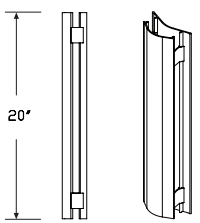

Y-leg with casters

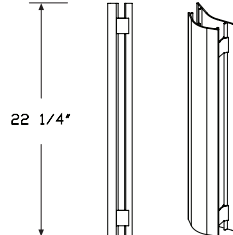

Y-leg with glides

Specification Information

Step 1.

DT9B.

Step 2. Leg Type

T T-leg

E Y-leg

Prices for Steps 1-2.

DT9B. T	\$264
E	\$264

Step 3. Caster or Glide Table

C	for table with caster base	+\$0
G	for table with glide base	+\$0

Step 4. Leg/Base Finish

8Q	folkstone grey	+\$0
91	white	+\$0
98	studio white	+\$0
BU	black umber	+\$0
CL	cool grey neutral	+\$0
G2	graphite satin	+\$0
HF	inner tone light	+\$0
LU	soft white	+\$0
MT	medium tone	+\$0
SG	slate grey	+\$0
WL	sandstone	+\$0
WN	warm grey neutral	+\$0
CN	metallic champagne	+\$0
EH	metallic bronze	+\$0
MS	metallic silver	+\$0

Everywhere™ Accessories

Modesty Panel

Y1113.

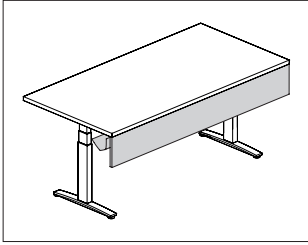

Product Information

Description

This modesty panel attaches to a table, desk, peninsula, or work surface. It has a solid MDF core with a laminate or veneer surface, aluminum top rail and attachment brackets. Cable trough is optional. Attachment hardware included.

Notes

Specify modesty panel to be equal to surface width, or 6" less than surface width of a height adjustable table.
 Modesty panel dimension is approximately 10" high with width specified in step 1. Actual width 1/4" less than specified value.
 Modesty panel is field installed.
 Brackets are located to work with Connect™ 2-circuit power system.
 Modesty panel (Y1113.) may impede ideal folding functionality of flip top table (DT5Ax.). For use with flip top table, modesty panel (Y1114.) is recommended. It comes only with a fabric surface.

Dimensions

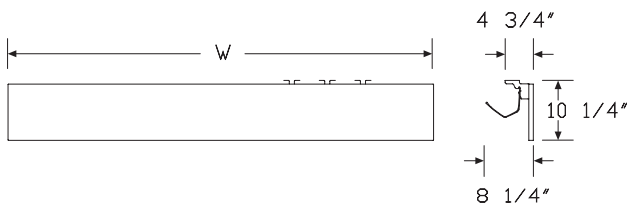

Specification Information

Step 1.

Y1113.

Step 2. Width

24	24" wide
30	30" wide
36	36" wide
42	42" wide
48	48" wide
54	54" wide
60	60" wide
66	66" wide
72	72" wide

Step 3. Cable Trough

N	without added cable trough
Y	with added cable trough

Step 4. Surface Material

L	laminate top/thermoplastic edge
W	veneer top/veneer edge

Prices for Steps 1-4.

		L	W
Y1113. 24	N	\$191	339
	Y	\$340	505
30	N	\$208	381
	Y	\$386	577
36	N	\$227	423
	Y	\$420	635
42	N	\$246	466
	Y	\$463	702
48	N	\$264	508
	Y	\$506	770
54	N	\$284	550
	Y	\$549	838
60	N	\$302	592
	Y	\$592	905
66	N	\$302	633
	Y	\$634	972
72	N	\$327	675
	Y	\$676	1039

Modesty Panel *continued*

Step 5. Finish

For laminate top/thermoplastic edge (L)

8Q	folkstone grey	+\$0
91	white	+\$0
LU	soft white	+\$0
WL	sandstone	+\$0
WN	warm grey neutral	+\$0

For veneer top/veneer edge (W)

2U	light brown walnut	+\$0
40	dark brown walnut	+\$0
UL	natural maple	+\$0

Fabric Modesty Panel

Y1114.

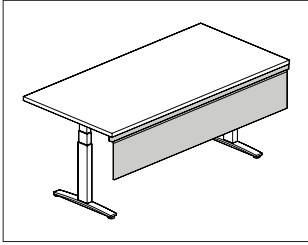

Product Information

Description

This modesty panel attaches to a table, desk, peninsula, or work surface. It has a fabric surface with aluminum top rail and attachment brackets. Attachment hardware included.

Notes

Specify modesty panel to be equal to surface width, or 6" less than surface width of a height adjustable table.

For use with flip top table (DT5Ax.), modesty panel (Y1114.) is recommended to enable optimal folding functionality of the table.

Dimensions



Everywhere™ Accessories

Specification Information

Step 1.

Y1114. A

Step 2. Width

24	24" wide	A
30	30" wide	A
36	36" wide	A
42	42" wide	A
48	48" wide	A
54	54" wide	A
60	60" wide	A
66	66" wide	A
72	72" wide	A

Prices for Steps 1-2.

Y1114. 24	\$175
30	\$190
36	\$206
42	\$218
48	\$233
54	\$262
60	\$275
66	\$290
72	\$301

Step 3. Fabric

Price Category 1	+ \$0
------------------	-------

Cable Trough

Y1200.

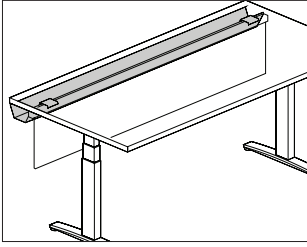

Product Information

Description

This trough attaches to a table, desk, peninsula, or work surface to hold and conceal cords and cables. It pivots down to allow easy access when laying cords inside, and can be specified with an optional modesty panel. The modesty panel has a fabric surface with aluminum top rail. Attachment hardware is included.

Notes

Specify trough to be equal to or less than the surface width.

Dimensions

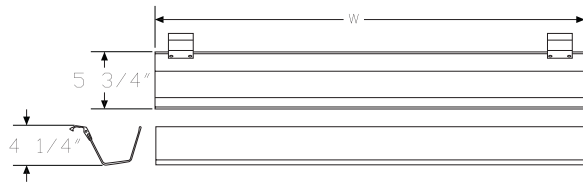

Specification Information

Step 1.

Y1200.

Step 2. Width

24	24" wide
30	30" wide
36	36" wide
42	42" wide
48	48" wide

Step 3. Modesty Panel Option

N	no modesty panel
M	modesty panel

Prices for Steps 1-3.

	N	M
Y1200. 24	\$277	354
30	\$302	398
36	\$333	434
42	\$364	475
48	\$392	516

Step 4. Cable Trough Finish

AN	clear anodized aluminum	+\$0
-----------	-------------------------	------

Step 5. Modesty Panel Fabric

For modesty panel (M)

Price Category 1	+\$0
------------------	------

Everywhere™ Accessories

Cable Management Trough, Work Surface Suspended AO382.

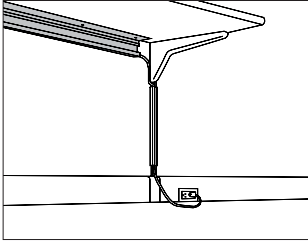

Product Information

Description
 This trough attaches under an Action Office® suspended work surface to manage cables. Attachment hardware is included.

Dimensions

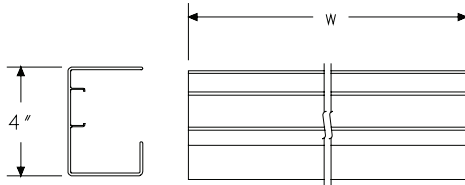

Specification Information

Step 1.

AO382.

Step 2. Width

- 30** 30" wide
- 40** 40" wide

Prices for Steps 1-2.

AO382. 30	\$76
40	\$93

Step 3. Surface Finish

BU	black umber	+ \$0
MT	medium tone	+ \$0

Cord Manager

FV984.

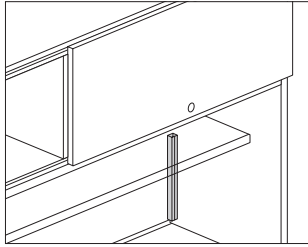

Product Information

Description

This cord manager routes a cord from the underside of a hutch to the surface when a task light is attached. Color is black. Package of 6.

Dimensions

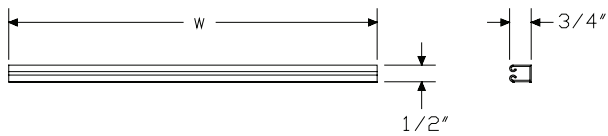

Specification Information

Step 1.

FV984.

Step 2. Height

12 12" high

24 24" high

30 29 1/2" high

Prices for Steps 1-2.

FV984. 12	\$77
24	\$117
30	\$142

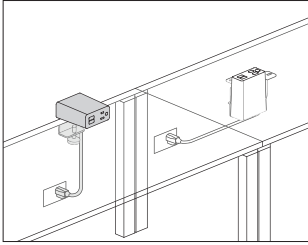

Product Information

Description

This electrical distributor plugs directly into floor, wall, or ceiling drop outlets. Each module configuration presents the same visual appearance. Cable clips and attachment hardware included. Product is UL listed.

Notes

- Cable clips for cord management are intended for a 1-time installation.
- Clamp versions can be reoriented in the field by a technician.
- A small LED light illuminates through the USB ports when the USB version is plugged in and powered.
- USB ports provide 10-watt power to charge most devices and tablets at full speed.
- Cord color is predetermined. For white (G1) finish cords will be white. For graphite (G1) finish cords will be black.
- Grommet mount attachment (Y1414.xxxG) does not come with the mini grommet. Order Logic mini grommet (Y1412.) separately, as needed.

Everywhere™ Accessories

Dimensions

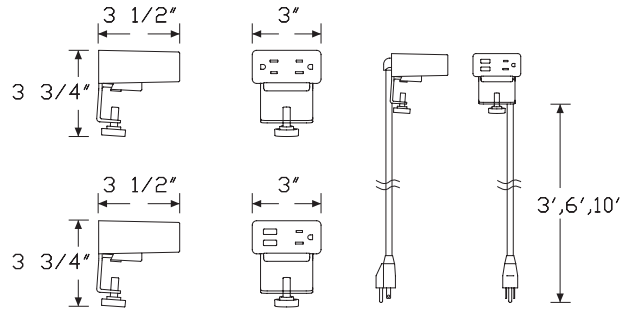

Surface Clamp

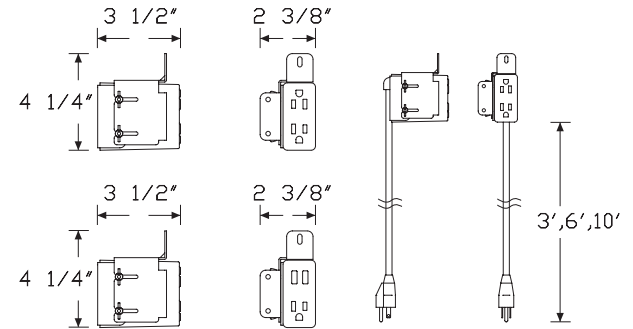

Grommet Mount

Specification Information

Step 1.

Y1414.

Step 2. Configuration

J 1 simplex receptacles, 2 powered USB

K 2 simplex receptacles

Step 3. Cord/Conduit Length

03 3' cord/conduit

06 6' cord/conduit

10 10' cord/conduit

Step 4. Attachment

G grommet mount

S surface clamp

Prices for Steps 1-4.

		G	S
Y1414. J	03	\$342	342
	06	\$342	342
	10	\$352	352
	K 03	\$191	191
	06	\$191	191
	10	\$201	201

Step 5. Finish

91 white +\$0

98 studio white +\$0

G1 graphite +\$0

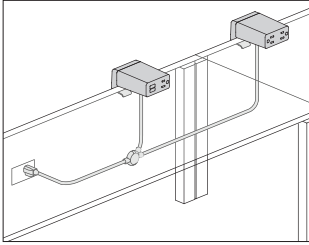

Product Information

Description

This electrical distributor plugs directly into floor, wall, or ceiling drop outlets. Each module configuration presents the same visual appearance. Cable clips and attachment hardware included. Product is ETL listed to UL962.

Notes

Cable clips for cord management are intended for a 1-time installation.

Clamp versions can be reoriented in the field by a technician.

Jumper length denotes distance between center points of each split point.

Cord length denotes distance from plug end to first split point.

All branch lengths from main power cord to module are 12".

A small LED light illuminates through the USB ports when the USB version is plugged in and powered.

USB ports provide 10-watt power to charge most devices and tablets at full speed.

The cord head contains a circuit breaker when there are more than 3 simplex receptacles.

Grommet mount attachment (Y1415.xxxG) does not come with the mini grommet. Order Logic mini grommet (Y1412.) separately, as needed.

Everywhere™ Accessories

Dimensions

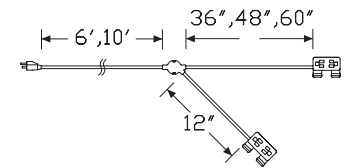
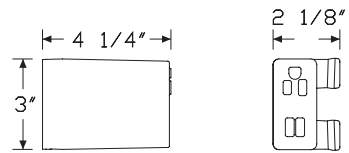

Two Power Modules

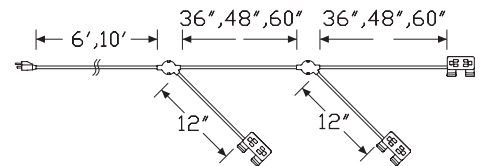

Three Power Modules

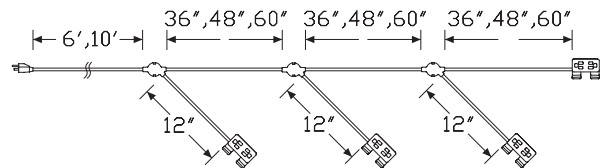

Four Power Modules

Specification Information

Step 1.

Y1415. A

Step 2. Number of Modules

- 2** two power modules A
- 3** three power modules A
- 4** four power modules A

Step 3. Power Type

- J** 1 simplex receptacles, 2 powered USB, all modules A
- K** 2 simplex receptacles, all modules A
- L** first module has 1 AC plus 2 powered USB all other modules have all AC simplex A

Step 4. Jumper Length

- 36** 36" between split points A
- 48** 48" between split points A
- 60** 60" between split points A

Step 5. Attachment

- G** grommet mount A
- S** surface clamp A

Step 6. Cord/Conduit Length

- 06** 6' cord/conduit A
- 10** 10' cord/conduit A

Prices for Steps 1-6.

		36G06	36G10	36S06	36S10	48G06	48G10
Y1415. 2	J	\$758	768	758	768	766	777
	K	\$454	465	454	465	462	473
	L	\$606	617	606	617	615	625
3	J	\$1129	1139	1129	1139	1145	1156
	K	\$689	700	689	700	707	717
	L	\$842	852	842	852	858	869
4	J	\$1533	1544	1533	1544	1558	1569
	K	\$925	935	925	935	951	961
	L	\$1077	1088	1077	1088	1102	1112
		48S06	48S10	60G06	60G10	60S06	60S10
Y1415. 2	J	\$766	777	775	786	775	786
	K	\$462	473	471	481	471	481
	L	\$615	625	623	633	623	633
3	J	\$1145	1156	1163	1173	1163	1173
	K	\$707	717	723	733	723	733
	L	\$858	869	876	886	876	886

4 J	\$1558	1569	1594	1605	1594	1605
K	\$951	961	975	986	975	986
L	\$1102	1112	1128	1138	1128	1138

Step 7. Finish

- 91** white A +\$0
- 98** studio white A +\$0
- G1** graphite A +\$0

Logic C1000 Universal Clamp Mount Distributor

Y1423.

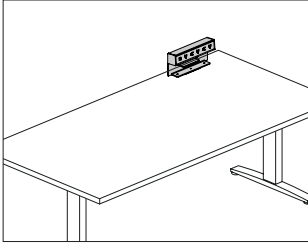

Product Information

Description

This Logic Power Access Solutions™ clamp mounted electrical distributor comes in several widths and configurations of simplex receptacles and USB charging ports. The unit is powered using a standard power cord with plug end or a hard-wired connection with electrical conduit. Data cords can be routed through the integrated opening at the rear of the unit. Product is UL listed.

Notes

Clamp mounts on worksurfaces 1"-1 1/4" thick.

Faceplate color matches unit color.

Simplex receptacles have alternating orientation and greater than normal plug spacing to accommodate most plug types.

USB ports supply 10-watt power and will charge most small electronic devices. Software in each device controls that devices ability to accept a charge via USB.

Everywhere™ Accessories

Dimensions



2 simplex receptacles, 2 powered USB

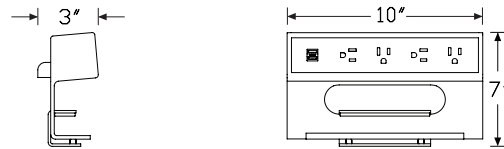

4 simplex receptacles, 2 powered USB

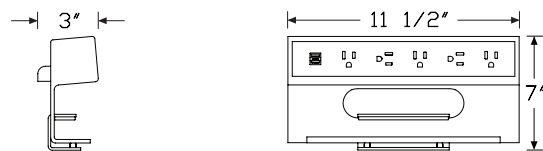

5 simplex receptacles, 2 powered USB



3 simplex receptacles

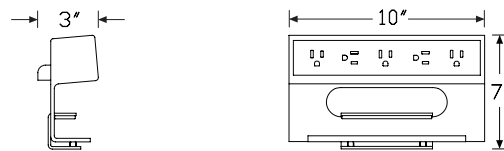

5 simplex receptacles

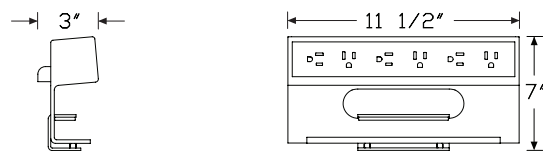

6 simplex receptacles

Logic C1000 Universal Clamp Mount Distributor *continued*

Specification Information

Step 1.

Y1423. A

Step 2. Configuration

- A** 2 simplex receptacles, 2 powered USB A
- C** 4 simplex receptacles, 2 powered USB A
- D** 5 simplex receptacles, 2 powered USB A
- E** 3 simplex receptacles A
- F** 5 simplex receptacles A
- G** 6 simplex receptacles A

Step 3. Power Type

- A** power cord with plug end A
- B** conduit with open end, for hard-wiring A

Step 4. Cord/Conduit Length

- 03** 3' cord/conduit A
- 06** 6' cord/conduit A
- 10** 10' cord/conduit A

Prices for Steps 1-4.

		03	06	10
Y1423. A	A	\$462	462	473
	B	\$513	513	523
C	A	\$555	555	565
	B	\$606	606	617
D	A	\$594	594	605
	B	\$645	645	656
E	A	\$310	310	321
	B	\$362	362	372
F	A	\$404	404	414
	B	\$454	454	465
G	A	\$442	442	453
	B	\$493	493	504

Step 5. Finish

- 91** white A +\$0
- 98** studio white A +\$0
- G1** graphite A +\$0
- MS** metallic silver A +\$0

Logic G1000 Grommet Mounted Electrical Distributor Y1425.

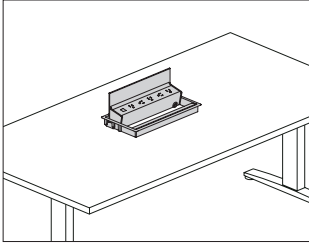

Product Information

Description

This Logic Power Access Solutions™ grommet mounted electrical distributor comes in several widths and configurations of simplex receptacles and USB charging ports. The unit is powered using a standard power cord with plug end, a hard-wired connection with electrical conduit, or an IEC connector when used with Renew™ Sit-to-Stand tables. An integrated cord keeper at the face of the unit captures data cords. The unit pivots from a closed position to 135° allowing easy access to power and data cords stored beneath the unit. Product is UL listed.

Notes

Field cutting of grommet cutout is possible.

IEC connector for Renew power type (C) includes short cord designed to connect to the Renew table power cord through-leg option. Actual cord length may vary.

Simplex receptacles have alternating orientation and greater than normal plug spacing to accommodate most plug types.

USB ports supply 10-watt power and will charge most small electronic devices. Software in each device controls that devices ability to accept a charge via USB.

Refer to Renew™ Sit-to-Stand Tables and Locale® planning guides for specific application information.

20' cord/conduit length (20) is recommended for Exclave® applications.

Everywhere™ Accessories

Dimensions

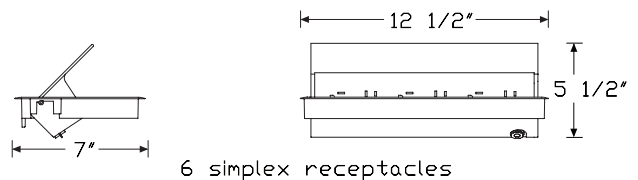
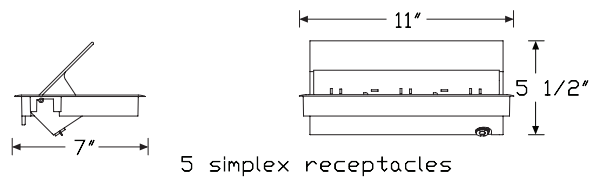
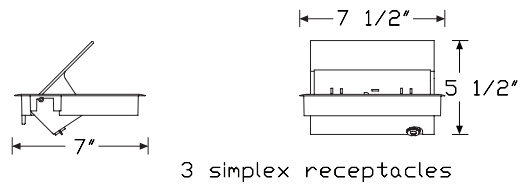
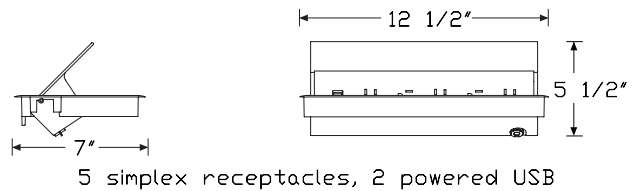
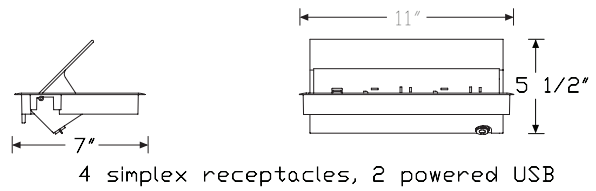
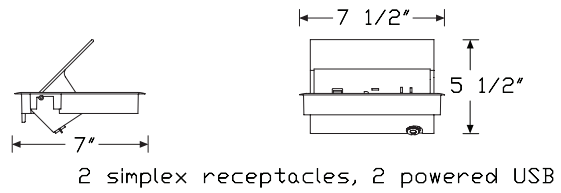

Logic G1000 Grommet Mounted Electrical Distributor *continued*

Specification Information

Step 1.

Y1425. A

Step 2. Configuration

- A** 2 simplex receptacles, 2 powered USB A
- C** 4 simplex receptacles, 2 powered USB A
- D** 5 simplex receptacles, 2 powered USB A
- E** 3 simplex receptacles A
- F** 5 simplex receptacles A
- G** 6 simplex receptacles A

Step 3. Power Type

- A** power cord with plug end A
- B** conduit with open end, for hard-wiring A
- C** IEC connector for Renew Tables A

Step 4. Cord/Conduit Length

For power cord with plug end (A)

- 03** 3' cord/conduit A
- 06** 6' cord/conduit A
- 10** 10' cord/conduit A
- 20** 20' cord/conduit A

For conduit with open end, for hard-wiring (B)

- 03** 3' cord/conduit A
- 06** 6' cord/conduit A
- 10** 10' cord/conduit A

For IEC connector for Renew Tables (C)

- 03** 3' cord/conduit A

Prices for Steps 1-4.

		03	06	10	20
Y1425. A	A	\$658	658	668	679
	B	\$709	709	719	—
	C	\$668	—	—	—
C	A	\$763	763	774	785
	B	\$814	814	825	—
	C	\$774	—	—	—
D	A	\$831	831	842	852
	B	\$882	882	892	—
	C	\$842	—	—	—
E	A	\$506	506	516	526
	B	\$556	556	567	—
	C	\$516	—	—	—

F	A	\$611	611	622	632
	B	\$662	662	673	—
	C	\$622	—	—	—
G	A	\$679	679	689	700
	B	\$729	729	741	—
	C	\$689	—	—	—

Step 5. Finish

- 91** white A +\$0
- 98** studio white A +\$0
- G1** graphite A +\$0
- MS** metallic silver A +\$0

Logic Mini Grommet

Y1412.

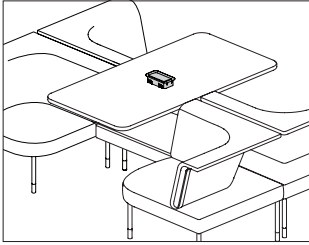

Product Information

Description

This Logic Power Access Solutions™ plastic grommet is available in mini rectangle or mini square configuration. The integrated flaps can hide the things below the surface while also retaining power and data cords.

Notes

This grommet is installed in some HermanMiller applications. Verify your application before ordering grommet separately.

Dimensions

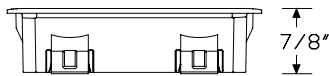
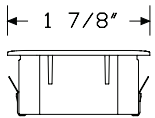
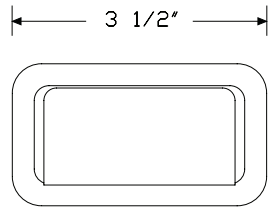

Grommet - Rectangle

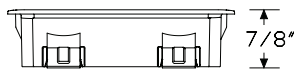
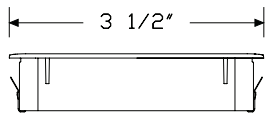
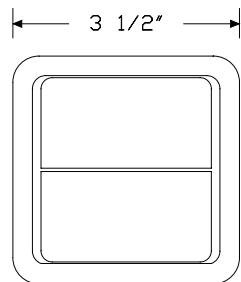

Grommet - Square

Specification Information

Step 1.

Y1412.

Step 2. Configuration

- 1 mini rectangle grommet
- 2 mini square grommet

Prices for Steps 1-2.

Y1412. 1	\$27
2	\$31

Step 3. Finish

91	white	+\$0
98	studio white	+\$0
G1	graphite	+\$0

Connect™-Ganging Bracket Kit

Y1338.

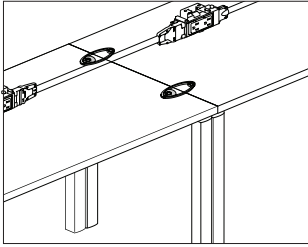

Product Information

Description

This kit has 2 clips that attach to the underside of 2 adjacent surfaces, ganging them together to provide stability and allowing electrical components to be routed from 1 surface to another. Finish is black.

Notes

Ganging bracket kit should not be used on 18"-deep Everywhere™ tables.

Dimensions

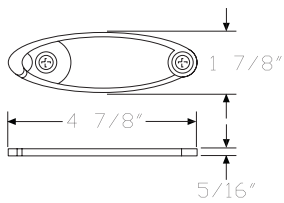

Specification Information

Step 1.

Y1338.

\$77

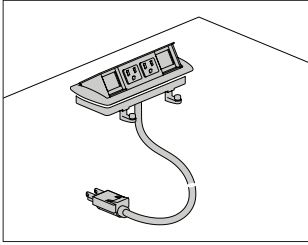

Product Information

Description

This electrical distributor mounts flush in a surface and has a one-touch pop-up mechanism for accessing power and data. It has 2 simplex receptacles and 2 data openings, and is available with a power cord with plug end, or electrical conduit for hardwire connection. A voice/data adapter kit is included, allowing the data openings to accept various manufacturers' couplers and jacks. Attachment hardware and cord/cable clips are also included. Product is UL listed.

Notes

Field cutting of surface may be required. Information on surface cutout size is included on instruction sheet.

Distributor with PVC-free wiring option (LZ) is Cradle to Cradle Silver Certified.

Dimensions

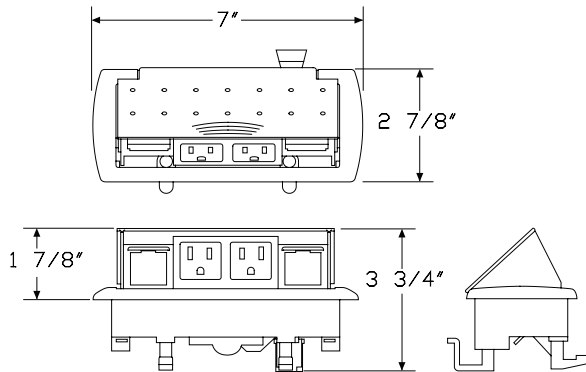

Everywhere™ Accessories

Specification Information

Step 1.

Y1321.

Step 2. Power Type

- A** power cord with plug end
- B** conduit with open end, for hard-wiring

Step 3. Cord/Conduit Length

- 03** 3' cord/conduit
- 06** 6' cord/conduit
- 10** 10' cord/conduit
- 20** 20' cord/conduit

Prices for Steps 1-3.

	03	06	10	20
Y1321. A	\$205	205	214	263
B	\$259	259	268	317

Step 4. Wiring Type

- 4Z** standard +\$0
- LZ** PVC-free +\$39

Step 5. Finish

- 0H** black +\$0

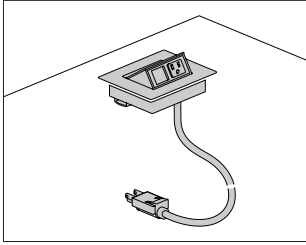

Product Information

Description

This electrical distributor mounts flush in a surface and has a one-touch pop-up mechanism for accessing power and data. It can be configured with 2 simplex receptacles, or 1 simplex receptacle and 1 data opening. The distributor is available with a power cord with plug end, or electrical conduit for hardwire connection. A voice/data adapter kit is included, allowing the data openings to accept various manufacturers' couplers and jacks. Attachment hardware and cord/cable clips are also included. Product is UL listed.

Notes

Field cutting of surface may be required. Information on surface cutout size is included on instruction sheet.

Distributor with PVC-free wiring option (LZ) is Cradle to Cradle Silver Certified.

Distributor with silver finish option (OI) or white finish option (OJ) and standard wiring (4Z) has painted metal trim with white plastic simplex/data interior. Distributor with black finish option (OH) and standard wiring (4Z) has black painted trim with black plastic simplex/data interior. Distributor with PVC-free wiring option (LZ) has black plastic simplex/data interior, regardless of the finish color.

Dimensions

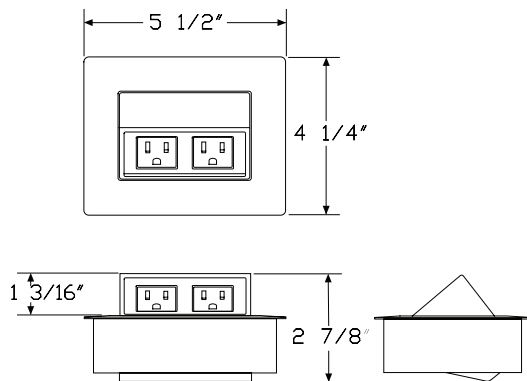

Specification Information

Step 1.

Y1322.

Step 2. Configuration

- 1 1 simplex receptacle, 1 data opening
- 2 2 simplex receptacles

Step 3. Power Type

- A power cord with plug end
- B conduit with open end, for hard-wiring

Step 4. Cord/Conduit Length

- 03 3' cord/conduit
- 06 6' cord/conduit
- 10 10' cord/conduit
- 20 20' cord/conduit

Prices for Steps 1-4.

		03	06	10	20
Y1322. 1	A	\$244	244	253	302
	B	\$297	297	306	353
	2 A	\$259	259	268	317
	B	\$311	311	322	371

Step 5. Wiring Type

- 4Z standard +\$0
- LZ PVC-free +\$39

Step 6. Finish

- OH black +\$0
- OI silver +\$0
- OJ white +\$0

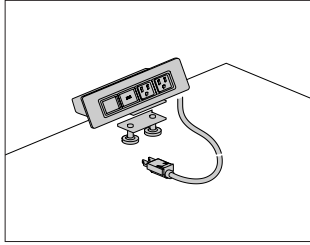

Product Information

Description

This electrical distributor can grommet-mount flush in a surface, or clamp-mount to the edge. It can be configured with several combinations of simplex receptacles, data openings, and USB charging ports. The distributor is available with a power cord with plug end, or electrical conduit for hardwire connection. A voice/data adapter kit is included, allowing the data openings to accept various manufacturers' couplers and jacks. Attachment hardware and cord/cable clips are also included. Product is UL listed.

Notes

Field cutting of surface may be required. Information on surface cutout size is included on instruction sheet.

Silver option (oI) and white option (oJ) have painted metal trim with white plastic simplex/data interiors. Black option (oH) has black painted trim with black plastic simplex/data interior.

Overall width for distributor with 4 openings is 8" wide. Overall width for distributor with 6 openings is 11" wide.

USB port charges at 2.1 amps.

Dimensions

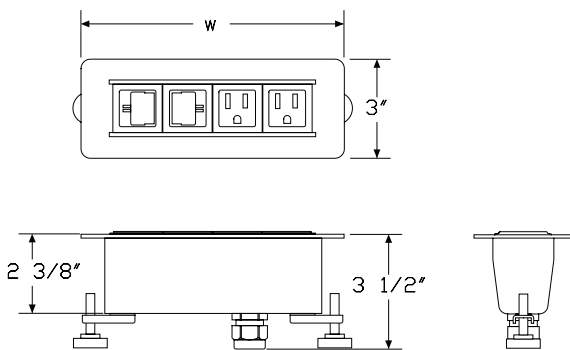

Everywhere™ Accessories

Specification Information

Step 1.

Y1323.

Step 2. Configuration

- 3** 2 simplex receptacles, 2 data openings
- 4** 3 simplex receptacles, 3 data openings
- 5** 2 simplex receptacles, 1 data opening, 1 charging USB port
- 6** 3 simplex receptacles, 2 data opening, 1 charging USB port

Step 3. Power Type

- A** power cord with plug end
- B** conduit with open end, for hard-wiring

Step 4. Cord/Conduit Length

- 03** 3' cord/conduit
- 06** 6' cord/conduit
- 10** 10' cord/conduit
- 20** 20' cord/conduit

Step 5. Attachment

- G** grommet mount
- S** surface clamp

Prices for Steps 1-5.

		03G	03S	06G	06S	10G	10S	
Y1323. 3	A	\$279	279	279	279	288	288	
	B	\$332	332	332	332	341	341	
4	A	\$347	347	347	347	356	356	
	B	\$402	402	402	402	412	412	
5	A	\$390	390	390	390	400	400	
	B	\$444	444	444	444	453	453	
6	A	\$459	459	459	459	469	469	
	B	\$513	513	513	513	523	523	
							20G	20S
Y1323. 3	A						\$337	337
	B						\$388	388
4	A						\$407	407
	B						\$459	459
5	A						\$449	449
	B						\$521	521
6	A						\$517	517
	B						\$592	592

Step 6. Finish		
OH	black	+\$0
OI	silver	+\$0
OJ	white	+\$0

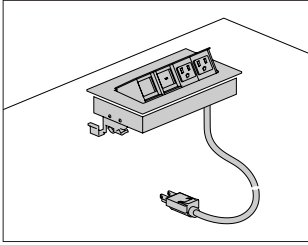

Product Information

Description

This electrical distributor mounts flush in a surface and has a one-touch pop-up mechanism for accessing power and data. It can be configured with several combinations of simplex receptacles, data openings, and USB charging ports. The distributor is available with a power cord with plug end, or electrical conduit for hardwire connection. A voice/data adapter kit is included, allowing the data openings to accept various manufacturers' couplers and jacks. Attachment hardware and cord/cable clips are also included. Product is UL listed.

Notes

Field cutting of surface may be required. Information on surface cutout size is included on instruction sheet.

Distributor with PVC-free wiring option (LZ) is Cradle to Cradle Silver Certified.

Distributor with silver anodized finish option (oK) and standard wiring (4Z) has anodized trim with white plastic simplex/data interior.

Distributor with silver anodized finish option (oK) and PVC-free wiring (LZ) has anodized trim with black plastic simplex/data interior.

Overall width for distributor with openings is 8 3/4" wide. Overall width for distributor with 7 openings is 12 3/4" wide.

USB port charges at 2.1 amps.

Dimensions

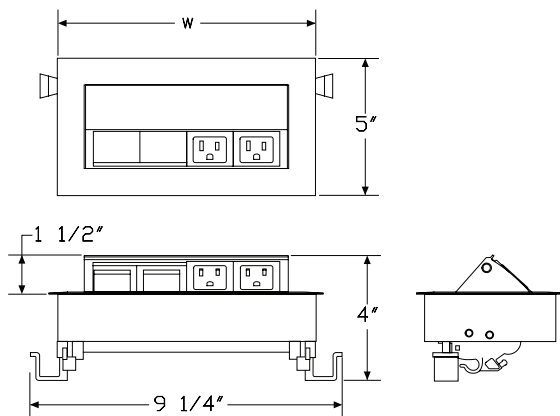

Specification Information

Step 1.

Y1324.

Step 2. Configuration

- 3** 2 simplex receptacles, 2 data openings
- 5** 3 simplex receptacles, 4 data openings
- 6** 2 simplex receptacles, 1 data opening, 1 charging USB port
- 7** 3 simplex receptacles, 3 data opening, 1 charging USB port
- 8** 3 simplex receptacles, 2 data opening, 2 charging USB ports

Step 3. Power Type

- A** power cord with plug end
- B** conduit with open end, for hard-wiring

Step 4. Cord/Conduit Length

- 03** 3' cord/conduit
- 06** 6' cord/conduit
- 10** 10' cord/conduit
- 20** 20' cord/conduit

Prices for Steps 1-4.

		03	06	10	20
Y1324. 3	A	\$388	388	398	447
	B	\$442	442	453	501
5	A	\$500	500	510	557
	B	\$553	553	559	607
6	A	\$501	501	510	557
	B	\$554	554	564	613
7	A	\$611	611	621	670
	B	\$665	665	672	719
8	A	\$723	723	732	782
	B	\$777	777	784	831

Step 5. Wiring Type

- 4Z** standard +\$0
- LZ** PVC-free +\$39

Step 6. Finish

- OK** silver anodized +\$0

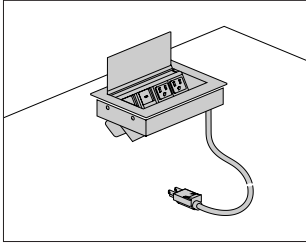

Product Information

Description

This electrical distributor mounts flush in a surface and has a flip-up lid for accessing power and data from above or below the surface. The flip lid can be closed once devices are connected for a clean visual appearance. It can be configured with several combinations of simplex receptacles, data openings, and USB charging ports. The distributor is available with a power cord with plug end, or electrical conduit for hardwire connection. A voice/data adapter kit is included, allowing the data openings to accept various manufacturers' couplers and jacks. Attachment hardware and cord/cable clips are also included. Product is UL listed.

Notes

Field cutting of surface may be required. Information on surface cutout size is included on instruction sheet.

Silver anodized option (oK) has anodized trim with white plastic simplex/data interior.

Overall width for distributor with 4 openings is 8³/₈" wide. Overall width for distributor with 6 openings is 11³/₈" wide.

USB port charges at 2.1 amps.

Dimensions

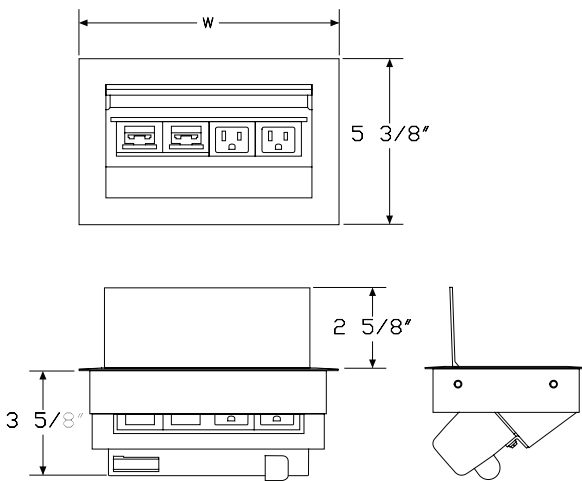

Specification Information

Step 1.

Y1325.

Step 2. Configuration

3	2 simplex receptacles, 2 data openings
7	3 simplex receptacles, 3 data openings
5	2 simplex receptacles, 1 data opening, 1 charging USB port
6	3 simplex receptacles, 2 data opening, 1 charging USB port

Step 3. Power Type

A	power cord with plug end
B	conduit with open end, for hard-wiring

Step 4. Cord/Conduit Length

03	3' cord/conduit
06	6' cord/conduit
10	10' cord/conduit
20	20' cord/conduit

Prices for Steps 1-4.

		03	06	10	20
Y1325. 3	A	\$458	458	468	516
	B	\$512	512	521	569
7	A	\$526	526	538	586
	B	\$580	580	591	639
5	A	\$571	571	580	628
	B	\$624	624	633	681
6	A	\$639	639	649	698
	B	\$691	691	705	751

Step 5. Finish

OK	silver anodized				+\$0
-----------	-----------------	--	--	--	------

Connect™ - S710 - Connect Single
Circuit Power Unit Y1371.

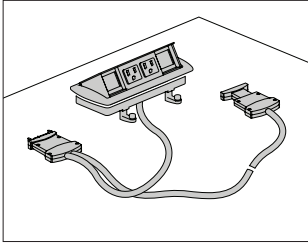

Product Information

Description

This dedicated modular single circuit electrical distributor mounts flush in a surface and has a one-touch pop-up mechanism for accessing power and data. It has 2 simplex receptacles and 2 data openings and a 60" cord. A maximum of 8 single circuit electrical distributors can be daisy chained per power entry. A voice/data adapter kit is included, allowing the data openings to accept various manufacturers couplers and jacks. Attachment hardware and cord/cable clips are also included.

Notes

Field cutting of surface may be required. For information on surface cutout size, see included instruction sheet.

UL listed when used in conjunction with most Everywhere™ fixed height tables.

To gang tables together per electrical code requirements, order ganging bracket kit (Y1338.) separately.

Order single circuit power entry (Y1377.) separately.

Where lengths of greater than 60" are needed, order single circuit jumpers (Y1378.) separately. Each single circuit jumper counts toward the 8 allowed electrical distributors per power entry.

Dimensions

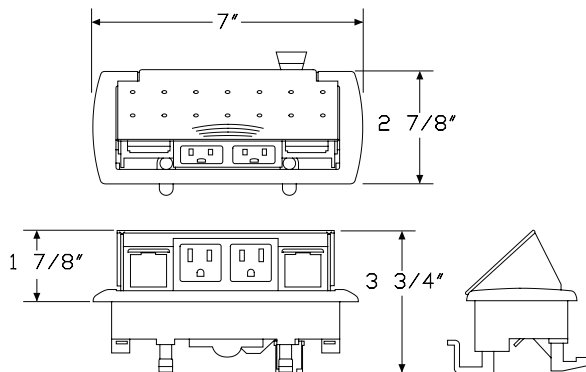

Specification Information

Step 1.

Y1371.

Step 2. Configuration

3 2 simplex receptacles, 2 data openings

Step 3. Cord Length

60 60" long

Prices for Steps 1-3.

	60
Y1371. 3	\$319

Step 4. Finish

0H black	+\$0
-----------------	-------------

Connect™ - S720 - Connect Single Circuit Power Unit Y1372.

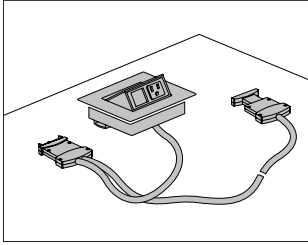

Product Information

Description

This dedicated modular single circuit electrical distributor mounts flush in a surface and has a one-touch pop-up mechanism for accessing power and data. It can be configured with 2 simplex receptacles, or 1 simplex receptacle and 1 data opening. Cord length is 60". A maximum of 8 single circuit electrical distributors can be daisy chained per power entry. A voice/data adapter kit is included, allowing the data openings to accept various manufacturers couplers and jacks. Attachment hardware and cord/cable clips are also included.

Notes

Field cutting of surface may be required. For information on surface cutout size, see included instruction sheet.
 UL listed when used in conjunction with most Everywhere™ fixed height tables.
 To gang tables together per electrical code requirements, order ganging bracket kit (Y1338.) separately.
 Order single circuit power entry (Y1377.) separately.
 Where lengths of greater than 60" are needed, order single circuit jumpers (Y1378.) separately. Each single circuit jumper counts toward the 8 allowed electrical distributors per power entry.
 Silver option (oI) and white option (oJ) have painted metal trim with white plastic simplex/data interiors. Black option (oH) has black painted trim with black plastic simplex/data interior.

Dimensions

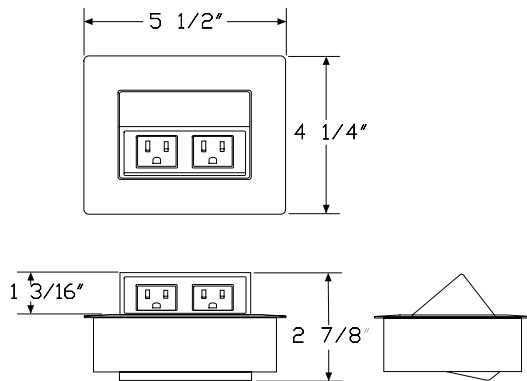

Specification Information

Step 1.

Y1372.

Step 2. Configuration

- 1 1 simplex receptacle, 1 data opening
- 2 2 simplex receptacles

Step 3. Cord Length

60 60" long

Prices for Steps 1-3.

	60
Y1372. 1	\$356
2	\$372

Step 4. Finish

oH	black	+\$0
oI	silver	+\$0
oJ	white	+\$0

Everywhere™ Accessories

Connect™ - S730 - Connect Single Circuit Power Unit Y1373.

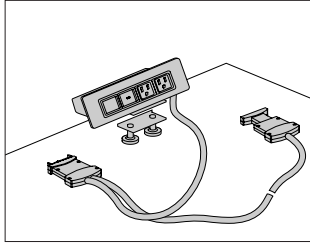

Product Information

Description
 This dedicated modular single circuit electrical distributor mounts flush in a surface or with an edge clamp mount. It has 2 simplex receptacles and 2 data openings, or 2 simplex receptacles and 1 data opening and 1 USB charging port, and a 60" cord. A maximum of 8 single circuit electrical distributors can be daisy chained per power entry. A voice/data adapter kit is included, allowing the data openings to accept various manufacturers' couplers and jacks. Attachment hardware and cord/cable clips are also included.

Notes

Field cutting of surface may be required. For information on surface cutout size, see included instruction sheet.
 UL listed when used in conjunction with most Everywhere™ fixed height tables.
 To gang tables together per electrical code requirements, order ganging bracket kit (Y1338.) separately.
 Order single circuit power entry (Y1377.) separately.
 Where lengths of greater than 60" are needed, order single circuit jumpers (Y1378.) separately. Each single circuit jumper counts toward the 8 allowed electrical distributors per power entry.
 Silver option (OI) and white option (OJ) have painted metal trim with white plastic simplex/data interiors. Black option (OH) has black painted trim with black plastic simplex/data interior.
 USB port charges at 2.1 amps.

Dimensions

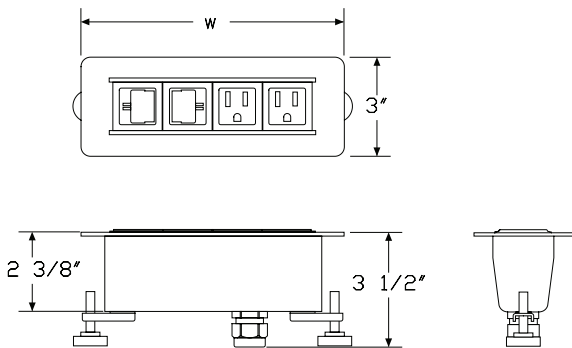

Specification Information

Step 1.

Y1373.

Step 2. Configuration

- 3** 2 simplex receptacles, 2 data openings
- 4** 2 simplex receptacles, 1 data opening, 1 charging USB port

Step 3. Cord Length

- 60** 60" long

Step 4. Attachment

- G** grommet mount
- S** surface clamp

Prices for Steps 1-4.

			G	S
Y1373.	3	60	\$402	390
	4	60	\$513	503

Step 5. Finish

- OH** black +\$0
- OI** silver +\$0
- OJ** white +\$0

Everywhere™ Accessories

Connect™ - S740 - Connect Single Circuit Power Unit Y1374.

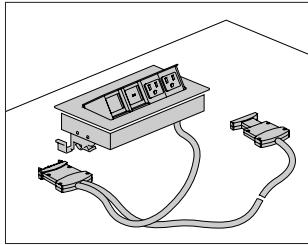

Product Information

Description

This dedicated modular single circuit electrical distributor mounts flush in a surface and has a one-touch pop-up mechanism for accessing power and data. It has 2 simplex receptacles and 2 data openings, or 2 simplex receptacles and 1 data opening and 1 USB charging port, and a 60" cord. A maximum of 8 single circuit electrical distributors can be daisy chained per power entry. A voice/data adapter kit is included, allowing the data openings to accept various manufacturers' couplers and jacks. Attachment hardware and cord/cable clips are also included.

Notes

Field cutting of surface may be required. For information on surface cutout size, see included instruction sheet.

UL listed when used in conjunction with most Everywhere™ fixed height tables.

To gang tables together per electrical code requirements, order ganging bracket kit (Y1338.) separately.

Order single circuit power entry (Y1377.) separately.

Where lengths of greater than 60" are needed, order single circuit jumpers (Y1378.) separately. Each single circuit jumper counts toward the 8 allowed electrical distributors per power entry.

Silver anodized option (oK) has anodized trim with white plastic simplex/data interior.

Overall width for distributor with 4 openings is 8 1/4" wide.

USB port charges at 2.1 amps.

Dimensions

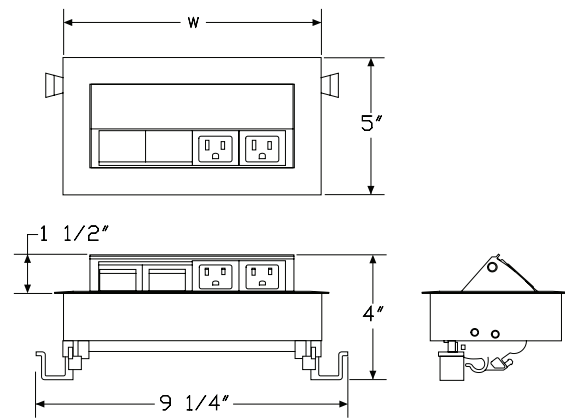

Connect™ - S740 - Connect Single
 Circuit Power Unit *continued*

Specification Information

Step 1.

Y1374.

Step 2. Configuration

3 2 simplex receptacles, 2 data openings

4 2 simplex receptacles, 1 data opening, 1 charging USB port

Step 3. Cord Length

60 60" long

Prices for Steps 1-3.

60

Y1374. 3 \$499

4 \$610

Step 4. Finish

OK silver anodized +\$0

Everywhere™ Accessories

Connect™ - S750 - Connect Single Circuit Power Unit Y1375.

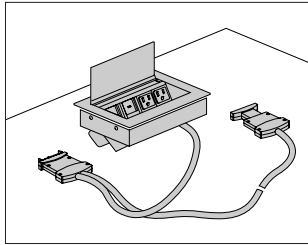

Product Information

Description

This dedicated modular single circuit electrical distributor mounts flush in a surface and has a flip-up lid for accessing power and data from above or below the surface. The lid can be closed once devices are connected for a clean visual appearance. The distributor has 2 simplex receptacles and 2 data openings, or 2 simplex receptacles and 1 data opening and 1 USB charging port, and a 60" cord. A maximum of 8 single circuit electrical distributors can be daisy chained per power entry. A voice/data adapter kit is included, allowing the data openings to accept various manufacturers' couplers and jacks. Attachment hardware and cord/cable clips are also included.

Notes

Field cutting of surface may be required. For information on surface cutout size, see included instruction sheet.

UL listed when used in conjunction with most Everywhere™ fixed height tables.

To gang tables together per electrical code requirements, order ganging bracket kit (Y1338.) separately.

Order single circuit power entry (Y1377.) separately.

Where lengths of greater than 60" are needed, order single circuit jumpers (Y1378.) separately. Each single circuit jumper counts toward the 8 allowed electrical distributors per power entry.

Silver anodized option (oK) has anodized trim with white plastic simplex/data interior.

Overall width for distributor with 4 openings is 8³/₈" wide.

USB port charges at 2.1 amps.

Dimensions

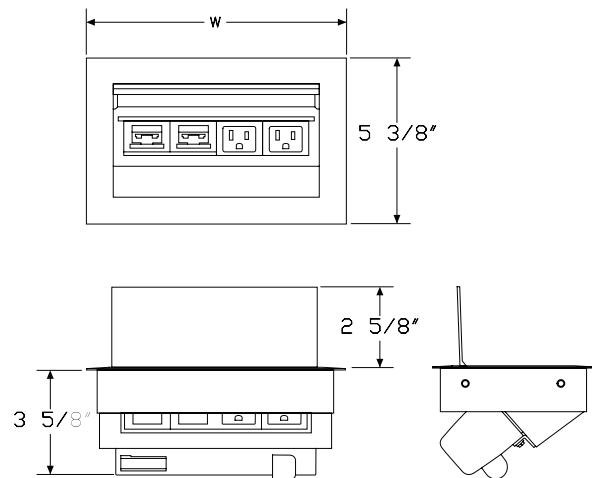

Connect™ - S750 - Connect Single Circuit Power Unit *continued*

Specification Information

Step 1.

Y1375.

Step 2. Configuration

3 2 simplex receptacles, 2 data openings

4 2 simplex receptacles, 1 data opening, 1 charging USB port

Step 3. Cord Length

60 60" long

Prices for Steps 1-3.

60

Y1375. 3 \$565

4 \$678

Step 4. Finish

OK silver anodized +\$0

Everywhere™ Accessories

Connect™ Single Circuit Electrical Power Entry Y1377.

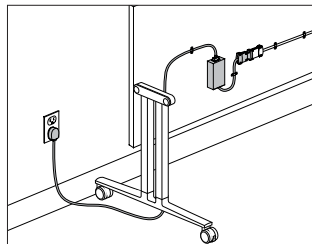

Product Information

Description

This standard receptacle 15-amp power entry provides power for single circuit electrical distributors. Up to 8 single circuit modular electrical distributors can be daisy chained and connected in any order. If more than 8 units are connected to this power entry, the system automatically shuts down and a red LED illuminates. A green LED indicates that more units can be connected and the system is ready. Standard attachment hardware is included.

Notes

UL listed when used in conjunction with most Everywhere™ fixed height tables.

Order electrical distributors (Y1371., Y1372., Y1373., Y1374., Y1375.) and single circuit jumpers (Y1378.) separately.

Dimensions

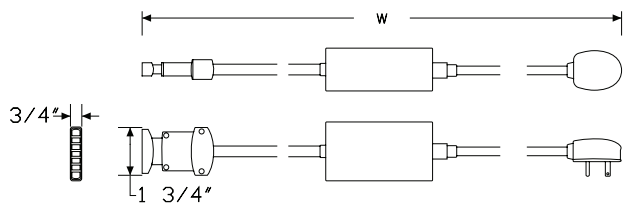

Specification Information

Step 1.

Y1377.

Step 2. Cord Length

06 6' long

10 10' long

Prices for Steps 1-2.

Y1377. 06	\$456
10	\$478

Connect™ Single Circuit Electrical By-Pass Jumper Y1378.

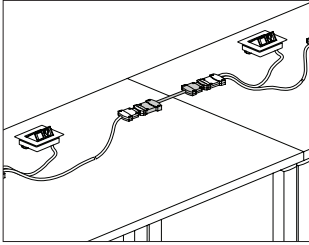

Product Information

Description
 This electrical jumper provides additional length for the Connect™ single circuit modular electrical system. Jumpers are available in a variety of lengths and count as one of the 8 electrical distributors allowed per power entry.

Notes
 UL listed when used in conjunction with most Everywhere™ fixed height tables.

Order electrical distributors (Y1371., Y1372., Y1373., Y1374., Y1375.) and single circuit power entry (Y1377.) separately.

Dimensions

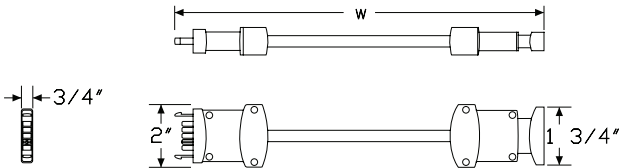

Everywhere™ Accessories

Specification Information

Step 1.
Y1378.

Step 2. Cord Length

12	12" long
24	24" long
36	36" long
48	48" long
60	60" long

Prices for Steps 1-2.

Y1378. 12	\$94
24	\$102
36	\$112
48	\$121
60	\$129

Index by Product Name

Everywhere™ Tables	
	page(s)
Cable Management Clip	90
Cable Management Trough, Work Surface Suspended	96
Cable Trough	95
Classroom Curve Table	44
Concave Rectangle	34
Conference Corner Table	47
Conference Table HD Trough	82
Connect™ - Ganging Bracket Kit	107
Connect™ - S100	108, 84
Connect™ - S200	109, 85
Connect™ - S300	110, 86
Connect™ - S400	112, 88
Connect™ - S500	113, 89
Connect™ - S710 - Connect Single Circuit Power Unit	114
Connect™ - S720 - Connect Single Circuit Power Unit	115
Connect™ - S730 - Connect Single Circuit Power Unit	116
Connect™ - S740 - Connect Single Circuit Power Unit	117
Connect™ - S750 - Connect Single Circuit Power Unit	119
Connect™ Single Circuit Electrical By-Pass Jumper	122
Connect™ Single Circuit Electrical Power Entry	121
Cord Manager	97
D-Shaped Table	23
Fabric Modesty Panel	94
Flip-Top Rectangular Table	53
Logic C1000 Universal Clamp Mount Distributor	102, 76
Logic G1000 Grommet Mounted Electrical Distributor	104, 78
Logic G1200 Grommet Pass Thru	81
Logic HD Cable Manager	83
Logic Mini	98, 72
Logic Mini Grommet	106, 80
Logic Mini - Vine	100, 74
Modesty Panel	92
Occasional Table, Round	69
Occasional Table, Square	66
Oval Table	19
Rectangular Table	5
Round Corner Table	50
Round Table	15
Soft Rectangle - Meeting Table	27
Soft Square Table	38
Square Table	11
Standard-Height Table Base	59
Standard-Height Table Leg	57
Standing-Height Round Table	63
Standing-Height Square Table	60
Tear Drop Table	41

Vertical Cord Covers	91
Video Oval - Meeting Table	31



Index by Product Number

A0382. Cable Management Trough, Work Surface			
Suspended		page(s)	96
DT1AE. Rectangular Table			5
DT1AS.			
DT1AT.			
DT1BE. Square Table			11
DT1BS.			
DT1BT.			
DT1CE. Round Table			15
DT1CS.			
DT1CT.			
DT1DE. Oval Table			19
DT1DS.			
DT1DT.			
DT1EE. D-Shaped Table			23
DT1ES.			
DT1ET.			
DT1FE. Soft Rectangle - Meeting Table			27
DT1FS.			
DT1FT.			
DT1GE. Video Oval - Meeting Table			31
DT1GS.			
DT1GT.			
DT1HE. Concave Rectangle			34
DT1HS.			
DT1HT.			
DT1JE. Soft Square Table			38
DT1JS.			
DT1JT.			
DT1KE. Tear Drop Table			41
DT1KS.			
DT1KT.			
DT1LE. Classroom Curve Table			44
DT1LS.			
DT1LT.			
DT1ME. Conference Corner Table			47
DT1MS.			
DT1MT.			
DT1NE. Round Corner Table			50
DT1NS.			
DT1NT.			
DT2A. Standard-Height Table Leg			57
DT2B. Standard-Height Table Base			59
DT3BE. Standing-Height Square Table			60
DT3BS.			
DT3BT.			
DT3CE. Standing-Height Round Table			63
DT3CS.			
DT3CT.			
DT4BS. Occasional Table, Square			66
DT4BT.			
DT4CS. Occasional Table, Round			69
DT4CT.			
DT5AE. Flip-Top Rectangular Table			53
DT5AS.			
DT5AT.			
DT9A. Cable Management Clip			90
DT9B. Vertical Cord Covers			91
DT9C. Conference Table HD Trough			82
FV984. Cord Manager			97
Y1113. Modesty Panel			92
Y1114. Fabric Modesty Panel			94
Y1200. Cable Trough			95
Y1321. Connect™-S100			108, 84
Y1322. Connect™-S200			109, 85
Y1323. Connect™-S300			110, 86
Y1324. Connect™-S400			112, 88
Y1325. Connect™-S500			113, 89
Y1338. Connect™-Ganging Bracket Kit			107
Y1371. Connect™ - S710 - Connect Single Circuit Power Unit			114
Y1372. Connect™ - S720 - Connect Single Circuit Power Unit			115
Y1373. Connect™ - S730 - Connect Single Circuit Power Unit			116
Y1374. Connect™ - S740 - Connect Single Circuit Power Unit			117
Y1375. Connect™ - S750 - Connect Single Circuit Power Unit			119
Y1377. Connect™ Single Circuit Electrical Power Entry			121
Y1378. Connect™ Single Circuit Electrical By-Pass Jumper			122
Y1412. Logic Mini Grommet			106, 80
Y1414. Logic Mini			98, 72
Y1415. Logic Mini - Vine			100, 74
Y1420. Logic G1200 Grommet Pass Thru			81
Y1423. Logic C1000 Universal Clamp Mount Distributor			102, 76
Y1424. Logic HD Cable Manager			83
Y1425. Logic G1000 Grommet Mounted Electrical Distributor			104, 78



20-Day or Less/Assigned Lead-Time Order Information

20-Day or Less and Assigned Lead-Time Programs

20-day or less and assigned lead-time products are designed for established Herman Miller dealers with pre-approved credit.

Products are distributed from multiple manufacturing facilities across the United States. All products and options not designated by an Assigned Lead-Time icon **A** will ship in 20 business days or less after being acknowledged by Herman Miller. Products and options designated by an **A** are on the assigned lead-time program and will ship in 20 days, less than 20 days, or more than 20 days from order acknowledgement.

Ordering Procedure

Please place orders through Order Manager. If this is not available to you, place orders through mail or fax. Verbal purchase orders will not be accepted.

Order Entry fax number for Passage®, 5000 Series, and Meridian® Filing and Storage: (616) 846 9236.

Order Entry fax number for all other products:
(616) 654 3085.

For more information, contact your Customer Care representative at:
(866) 854 3048 EXT 3400.

Shipments and Delivery

Per Herman Miller Terms and Conditions.

Changes and Cancellation

Per Herman Miller Terms and Conditions.



Vary Easy Program

Program Overview

Vary Easy is a program designed to help dealers specify standard products with a larger breadth of options. For example, depending on the type of product being specified, choices include additional size, finish, edge types, and cable management features. Vary Easy 3D, specIT, and third-party text-based specification packages support the Vary Easy program. Vary Easy 3D enables designers to create a 3D image, CAD symbols, and a price book page. A Vary Easy product number is assigned for each product as the user selects specific options. Once the product is completely specified, the order can be submitted via Kiosk's Order Manager or a dealer's business system.

Accessing and Specifying Vary Easy

To view the full product vocabulary, go to the Vary Easy Product Offering on Kiosk. To specify Vary Easy, go to the Vary Easy 3D website on Kiosk, specIT, or your third-party text-based specification package.

Once you've made your product line selection, continue to follow through each option and enter the specific options that represent the product you need. When the product is fully specified, Vary Easy will generate an orderable product number and instantly calculate a price.

Note: Failure to completely specify a product will cause a delay in order acknowledgements. Be sure to make a selection for all options offered.

The acknowledgement process for Vary Easy products is the same as for any standard order. Vary Easy products ship with a standardized lead time and are competitively priced.

For more information, contact your Customer Care Line at (866) 854 3048 EXT 3400.

Stain-to-Match Program

Stain-to-Match Program

Program Overview

The Stain-to-Match program gives you the option of using veneer finishes that are not listed in the standard offering. The program allows Herman Miller to match a customer's existing recut or natural veneer, or create a new finish that is unique to an installation.

Specific information on approval, ordering, pricing, and warranty for the Stain-to-Match program is listed below. Questions and requests for assistance may be directed to Herman Miller Options at:

(800) 654 3910

Stain-to-Match Process

1. Fill out the Options Stain-to-Match Request Form and send along with a color sample (2" x 3" minimum) to the Herman Miller Options Applications Team at the address provided on the form. The form can be found on Omni.
2. Within 7-10 working days, Herman Miller Options will send a sample of the color-matched stain on Herman Miller veneer to the requester for the customer's signed approval.
3. If the sample meets the customer's approval, sign the reverse side of the sample, scan and email the approval to:
options@hermanmiller.com.
4. After the stain has been approved, a formal quotation with special number and pricing can be provided, or the product can be specified through the Vary Easy program, if available. Work with the Options team on final product needs and how to specify.
5. A purchase order can then be placed.

Stain-to-Match Warranty

Herman Miller warrants its products to be free from defects in craftsmanship from the date of delivery for the applicable warranty period. Herman Miller is responsible for the physical properties of the veneers available through the Stain-to-Match program, which include:

- STA: Stain-to-Match on Recut Ash
- STB: Stain-to-Match on Beech
- STC: Stain-to-Match on Cherry
- STD: Stain-to-Match on Oak
- STK: Stain-to-Match on Reltech Anigre (Geiger)
- STM: Stain-to-Match on Recut Mahogany
- STP: Stain-to-Match on Maple
- STU: Stain-to-Match on Walnut (Geiger)

See your specification tool for product specific finish offering limitations.

For more information about our products and services or to see a list of dealers, please visit us at HermanMiller.com or call (800) 851 1196.

© 2018 Herman Miller, Inc., Zeeland, Michigan

® **HermanMiller**, 3D Intelligent, AO, Action Office, Aeron, ArcSpan, Aside, Avall, Avive, Bubble Lamps, Canvas Office Landscape, Caper, Celle, Co/Struc, Daisiyone, Distil, Eames, Eco-Dematerialized, Embody, Envelop, Equa 2, Ergon 3, Ethospace, Exclave, Fine-Tune, FlexFront, Flo, Formcoat, Formwork, Ground Cloth, Herman Miller for the Home, Herman Miller for Healthcare, Intersect, Kinemat, Lapjack, Layout Studio, Lifework, Limerick, Live Unframed, Living Office, Locale, Maharam, Meridian, Mirra, Passage, Pellicle, Perspectives, PostureFit, Public Office Landscape, Resolve, Rodney, Sayl, Setu, Thrive, Tu, Wishbone, and Y-Tower are among the registered trademarks of Herman Miller, Inc., and its owned subsidiaries.

™ 8Z Pellicle, About Face, AireWeave, Albert, Backfit, Bubbletack, Burdick Group, Butterfly Back, Celeste, Cellular Suspension, Clam, Compass, Connect, Cosm, Cubert, DOT, Duracare, Durawrap, Eames Soft Pad, EnhancedAccess, Everywhere, Flex-Edge, Flute, Harmonic, Herman Miller Select, Hopsak 2, Intent, Iota, Jaw, Keyless Entry, Keyn Chair Group by Herman Miller, Latitude, Lino, Locale, Logic Mini, Logic Power Access Solutions, Live OS, Loop, Lyris, Lyris 2, Made-to-Measure Storage, Metaform Portfolio, Mora, Motia, Multiscrim, Nelson, Pari, Pixelated Support, Plex, PostureFit SL, Prospect, Q, Renew, Sense, Soft Pad, Stackable, Stackable Storage, Striad, Swoop, Tone, TriFlex, Twist, Ubi, Verus and Wireframe are among the trademarks of Herman Miller, Inc., and its owned subsidiaries.

SM Herman Miller Options is among the service marks of Herman Miller, Inc.

Alexander Girard® is a registered trademark of The Alexander Girard Estate.

Chemsurf® is a registered trademark of Wilsonart International.

Corian® is a registered trademark of E. I. du Pont de Nemours and Company Corporation.

Crypton® is a registered trademark of Crypton, Inc.

DACRON® is a registered trademark of INVISTA S.a r.l.

Edelman® Leather is a registered trademark of Edelman Leather, Inc.

FENIX NTM® is a registered trademark of Arpa Industriale S.p.A.

FLEXNET™ is a trademark of Milliken & Company.

Floor Saver Glide® is a registered trademark of Carpin Manufacturing, Inc.

Geiger® is a registered trademark, and Bumper™, Saiba™, and Ward Bennett™ are trademarks, of Geiger International.

Goetz™ is a trademark of Mark W. Goetz.

Hang-It-All® is a registered trademark of Lucia Eames Demetrios, d.b.a. Eames Office.

Holophane® is a registered trademark of Holophane.

Ingeo™ is a trademark of Cargill Dow LLC.

iPad® is a registered trademark of Apple, Inc.

LifeSize® is a registered trademark of LifeSize Communications, Inc.

Magis®, Bombo®, and Me Too® are registered trademarks of Magis S.p.A.

Microsoft® and Natural® Keyboard are registered trademarks of Microsoft Corporation.

Noguchi® and the Noguchi table configuration (trade dress) are registered trademarks, and Rudder Table™ is a trademark, of The Isamu Noguchi Foundation and Garden Museum.

Place Textiles® is a registered trademark of Place Textiles.

SuperSeat™ is a trademark of Dahti Seating, a division of ITW.