

# LEM S80 | Height-adjustable stool

**Shin & Tomoko Azumi** | 2000



# LEM

Shin & Tomoko Azumi | 2000

In 1969, man landed on the moon in the LEM (Lunar Excursion Module). In 2000, at the turn of the millennium, the LEM stool was created, one of the symbols of Lapalma's style. The same lightness, the same absence of gravity, which, in the void created by the design, fosters its relationship with the environment. And like the Apollo 11, it could not bear unnecessary weights, therefore this amazing chair incorporated all functions in a highly elegant minimalist profile. Only the essential, the rest stayed on the ground.



# LEM

Shin & Tomoko Azumi | 2000



## S80 | Height-adjustable stool Powder-coated frame H66 ÷ 79

### LEM | S79 S80 S81 S83

Stool with swivel seat and fix or adjustable height with metal frame mat chromed and base covered by a stainless steel sheet "linen fabric" pattern or entirely powder coated black or white. Seat available in several finishes. Also available with "self-return mechanism" for the seat and floor fixing base Ø 20 cm.

TEST DIN 68 877/81 5.6

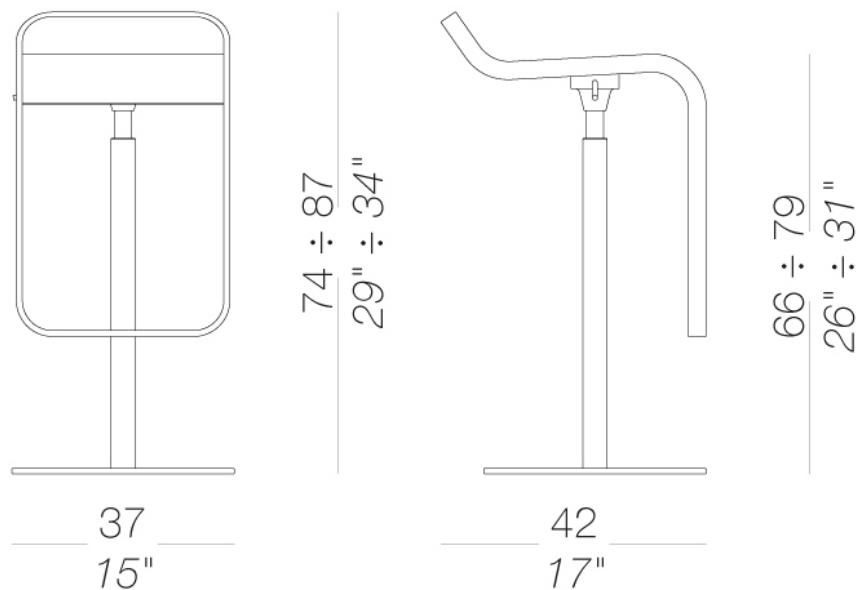

# LEM S80 | Height-adjustable stool

Shin & Tomoko Azumi | 2000

## frame



powder coating  
black  
1 Colors

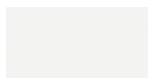

powder coating  
white  
1 Colors



powder coating  
arancione  
1 Colors

## seat



wood  
blanch oak  
1 Colors

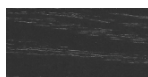

wood  
black open pore  
1 Colors



wood  
oak dark walnut  
1 Colors

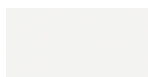

lacquered  
lacquered  
2 Colors



laminate  
fenix 9/10  
2 Colors



laminate  
millerighe  
aluminium  
1 Colors



laminate  
406 millerighe  
1 Colors



fabric  
Hallingdal 65  
47 Colors



fabric  
Canvas 2  
40 Colors



fabric  
Steelcut Trio 3  
48 Colors



fabric  
Remix 2  
24 Colors



fabric  
Clara 2  
24 Colors

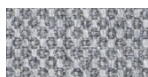

fabric  
Fiord  
24 Colors



fabric  
Divina MD  
24 Colors



fabric  
Divina Melange 2  
24 Colors

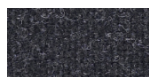

fabric  
Tonica 2  
39 Colors



fabric  
Medley  
37 Colors



fabric  
Swing  
24 Colors

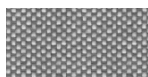

fabric  
Maya  
43 Colors



fabric  
Jet  
44 Colors



fabric  
Laser J Flash  
24 Colors



ecoleather  
GRIMM FR  
24 Colors



leather  
leather  
7 Colors

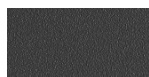

plastics  
grey polyurethane  
1 Colors



plastics  
polyurethane  
orange  
1 Colors

**consult the portfolio for the range of colors, fabrics, eco-leather, soft-leather.**

## use and maintenance instructions

Clean all parts in wood, leather, fabric and metal with a damp cloth or a diluted neutral cleaner. Do not use cleaners with alcohol, bleach, solvent or abrasive products. Any liquid spilt on the product must be wiped up immediately. When lifting or moving the product, hold it on the structure and not under the seat. The product should not be subjected to unbalanced weights, as it is designed for a proper rest on the foothold (on four legs or on the base). Our company relieves from any responsibility in case of damage caused to fragile floors. Avoid any improper use of the product: do not step on the product, on the footrest or on the armrests. Avoid any movements that could compromise the proper functionality of the product or the safety of the users. Wood and leather, being natural materials, could be easily damaged. Small impurities or imperfections are within quality standard range. Do not expose the product to weather conditions or atmospheric agents, nor to heat sources over 40°C. Also products for outdoor use could be afflicted by atmospheric agents. The product could undergo possible exterior changes due to particular exposure to heat, humidity and saltiness. An appropriate and frequent maintenance and cleaning of the product enhances its durability. The product could change colour and shade, if exposed to direct sunlight. Maintenance has to be carried out by experienced staff. Dispose of the package only after assembling the product, in order to avoid the loss of ironmongery and components. Once the product has been dismantled, the product itself or its components must be given to the public garbage disposal system, according to the legislation in force.