

# LEM S79 | Height-adjustable stool

Shin & Tomoko Azumi | 2000



# LEM

Shin & Tomoko Azumi | 2000

In 1969, man landed on the moon in the LEM (Lunar Excursion Module). In 2000, at the turn of the millennium, the LEM stool was created, one of the symbols of Lapalma's style. The same lightness, the same absence of gravity, which, in the void created by the design, fosters its relationship with the environment. And like the Apollo 11, it could not bear unnecessary weights, therefore this amazing chair incorporated all functions in a highly elegant minimalist profile. Only the essential, the rest stayed on the ground.



# LEM

Shin & Tomoko Azumi | 2000



## S79 | Height-adjustable stool Chromed frame H55 ÷ 67

### LEM | S79 S80 S81 S83

Stool with swivel seat and fix or adjustable height with metal frame mat chromed and base covered by a stainless steel sheet "linen fabric" pattern or entirely powder coated black or white. Seat available in several finishes. Also available with "self-return mechanism" for the seat and floor fixing base Ø 20 cm.

TEST DIN 68 877/81 5.6

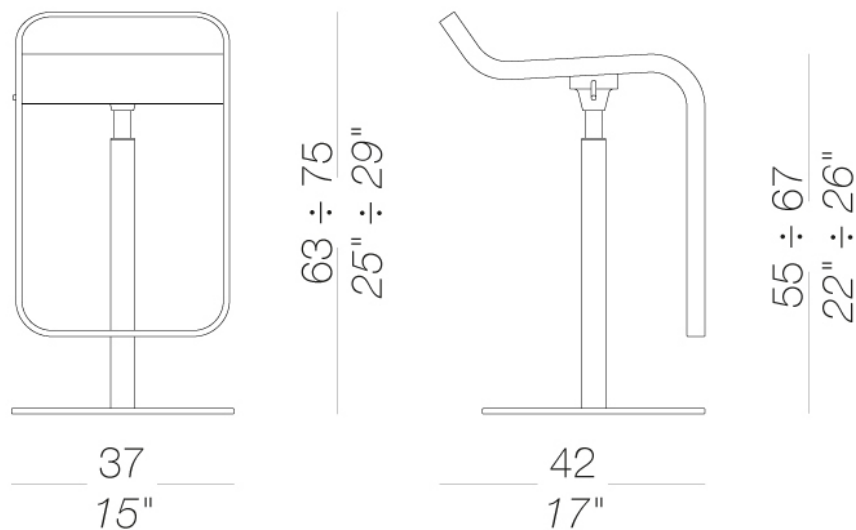

# LEM S79 | Height-adjustable stool

Shin & Tomoko Azumi | 2000

## frame



metal

mat chromed

1 Colors

## seat

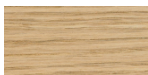

wood

blanch oak

1 Colors

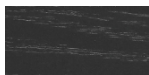

wood

black open pore

1 Colors



wood

oak dark walnut

1 Colors

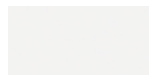

lacquered

lacquered

2 Colors



laminate

fenix 9/10

2 Colors



laminate

millerighe

aluminium

1 Colors



laminate

406 millerighe

1 Colors

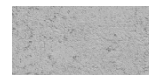

concrete

concrete

1 Colors



metal

stainless steel

1 Colors



fabric

Hallingdal 65

47 Colors

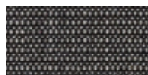

fabric

Canvas 2

40 Colors



fabric

Steelcut Trio 3

48 Colors

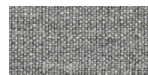

fabric

Remix 2

24 Colors



fabric

Clara 2

24 Colors



fabric

Fiord

24 Colors

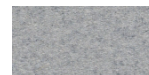

fabric

Divina MD

24 Colors



fabric

Divina Melange 2

24 Colors



fabric

Tonica 2

39 Colors



fabric

Medley

37 Colors



fabric

Swing

24 Colors

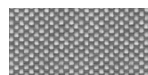

fabric

Maya

43 Colors



fabric

Jet

44 Colors



fabric

Laser J Flash

24 Colors



ecoleather

GRIMM FR

24 Colors



leather

leather

7 Colors

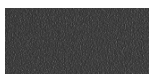

plastics

grey polyurethane

1 Colors

**consult the portfolio for the range of colors, fabrics, eco-leather, soft-leather.**

## use and maintenance instructions

Clean all parts in wood, leather, fabric and metal with a damp cloth or a diluted neutral cleaner. Do not use cleaners with alcohol, bleach, solvent or abrasive products. Any liquid spilt on the product must be wiped up immediately. When lifting or moving the product, hold it on the structure and not under the seat. The product should not be subjected to unbalanced weights, as it is designed for a proper rest on the foothold (on four legs or on the base). Our company relieves from any responsibility in case of damage caused to fragile floors. Avoid any improper use of the product: do not step on the product, on the footrest or on the armrests. Avoid any movements that could compromise the proper functionality of the product or the safety of the users. Wood and leather, being natural materials, could be easily damaged. Small impurities or imperfections are within quality standard range. Do not expose the product to weather conditions or atmospheric agents, nor to heat sources over 40°C. Also products for outdoor use could be afflicted by atmospheric agents. The product could undergo possible exterior changes due to particular exposure to heat, humidity and saltiness. An appropriate and frequent maintenance and cleaning of the product enhances its durability. The product could change colour and shade, if exposed to direct sunlight. Maintenance has to be carried out by experienced staff. Dispose of the package only after assembling the product, in order to avoid the loss of ironmongery and components. Once the product has been dismantled, the product itself or its components must be given to the public garbage disposal system, according to the legislation in force.