

# Aava

## Design by Antti Kotilainen, 2013

### Art. 3920 3923

Chair with steel sled base with writing tablet (right or left side) and curved plywood shell, veneered natural birchwood effect or lacquered birchwood effect in 4 different colors. Glides with felt insert for wood floors are provided upon request without surcharge. A non-washable, removable cover (Item 3920) is also available in leather, faux leather, fabric or customer's material allowing the chair to be used in two versions: wood or upholstered.



### Dimensions \*

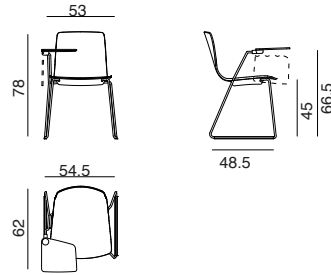

\* File CAD 2D - 3D available for download at [www.arper.com](http://www.arper.com)

### Wood



arper

F +39 0422 791800

T +39 0422 7918

[www.arper.com](http://www.arper.com)

# Aava

Design by Antti Kotilainen, 2013

---



Single trolley Art. 0500





Link Art. 3941

---

## SHIPMENT DETAILS

### Art.3920

1 pz = 1  - kg 3/ m³ 0,04

4 pz = 1  - kg 8/ m³ 0,04

1 pz = 3  - kg 12,86/ m³ 0,3

4 pz = 3  - kg 36,64/ m³ 0,4

---

## RESISTANCE TEST

---

## ENVIRONMENTAL CERTIFICATIONS

---

## TECHNICAL SPECIFICATIONS

### Art.

COL requirement m² 1,56

H 140 cm. COM Meterage ml 0.99

---

## FIRE RETARDANT TEST

Classe 1M Faux leather Valencia • California TB117-2013 Cava 3 Clara Canvas Divina MD Divina Melange 2 Divina 3 Soft leather Elmosoft Field Hallingdal 65 Jet Jumper 3 Pro 3 Soft leather Pause 4 Remix 2 Savanna Steelcut 2 Scuba Steelcut Trio 2 Steelcut Trio 3 Sunniva Sunniva 2 Tonus 4 Tempo Faux leather Valencia • BS5852 Sch. 4 Part 1 Faux leather Valencia • BS5852 Sch. 5 Part 1 Cava 3 Clara Canvas Divina MD Divina Melange 2 Divina 3 Soft leather Elmosoft Hallingdal 65 Soft leather Remix 2 Savanna Steelcut 2 Steelcut Trio 2 Steelcut Trio 3 Tonus 4 Faux leather Valencia

arper

F +39 0422 791800

T +39 0422 7918

www.arper.com

# Aava

Design by Antti Kotilainen, 2014

## Art. 3926

Chair with steel sled base with writing tablet (right or left side) and curved plywood shell, veneered natural birchwood effect, or lacquered birchwood effect in 4 different colors. The shell is fitted with leather, faux leather, fabric or customer's material front upholstery. Glides with felt insert for wood floors are provided upon request without surcharge.



### Dimensions \*

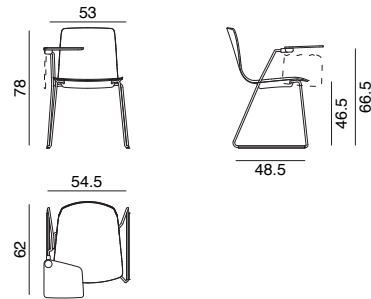

\* File CAD 2D - 3D available for download at [www.arper.com](http://www.arper.com)

### Frame Base



CRO

### Shell

#### Wood



#### Carded In

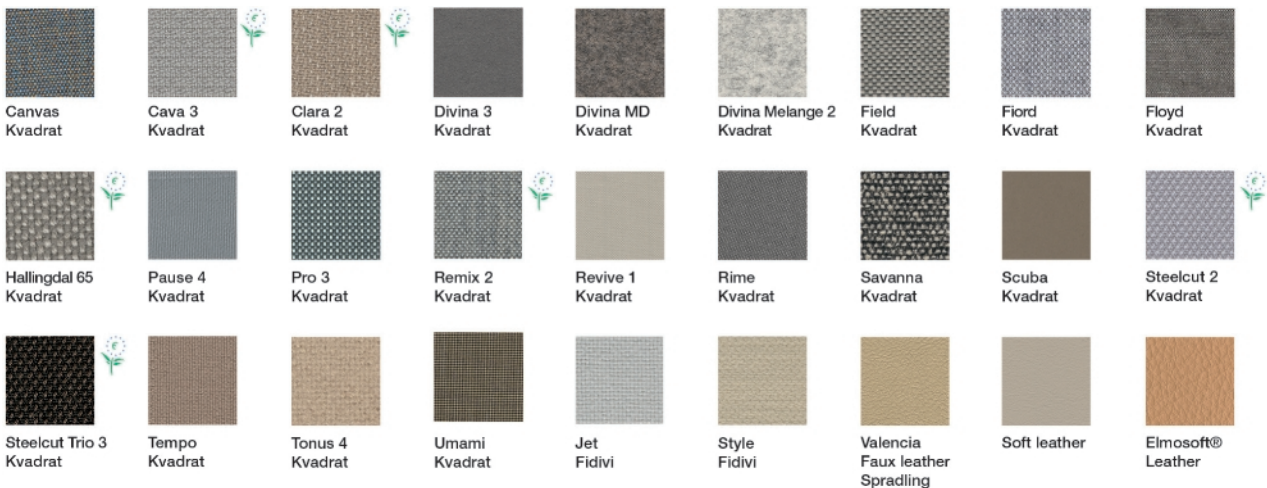

#### Graded In

**kvadrat**

**camira**



DESIGN  
TEX



**Gabriel**



**svensson**

**maharam**

**Serge Ferrari**

# Aava

## Design by Antti Kotilainen, 2014

---

### Accessories:



Single trolley Art. 0500



Link Art. 3941



Stacking protection Pad Art. 3942

---

### SHIPMENT DETAILS

#### Art.3926

1 pz = 3  - kg 12,86/ m<sup>2</sup> 0,3

4 pz = 3  - kg 36,64/ m<sup>2</sup> 0,4

---

### TECHNICAL SPECIFICATIONS

#### Art.3926

COL Lederverbrauch m<sup>2</sup> 0.78

H 140 cm. COM Stoffverbrauch ml 0.66

---

### RESISTANCE TEST

---

### FIRE RETARDANT TEST

Classe 1IM Faux leather Valencia • California TB117-2013 Cava 3 Clara Canvas Divina MD Divina Melange 2 Divina 3 Soft leather Elmosoft Field Hallingdal 65 Jet Jumper 3 Pro 3 Soft leather Pause 4 Remix 2 Savanna Steelcut 2 Scuba Steelcut Trio 2 Steelcut Trio 3 Sunniva Sunniva 2 Tonus 4 Tempo Faux leather Valencia • BS5852 Sch. 4 Part 1 Faux leather Valencia • BS5852 Sch. 5 Part 1 Cava 3 Clara Canvas Divina MD Divina Melange 2 Divina 3 Soft leather Elmosoft Hallingdal 65 Soft leather Remix 2 Savanna Steelcut 2 Steelcut Trio 2 Steelcut Trio 3 Tonus 4 Faux leather Valencia

---

### ENVIRONMENTAL CERTIFICATIONS

---

### Stackability:

- With stacking protection pad: up to 6 pcs. (should the weight exceed 25 kilos a handling tool must be used).
- With stacking protection pad and trolley: up to 6 pcs.

arper

F +39 0422 791800

T +39 0422 7918

www.arper.com

# Aava

Design by Antti Kotilainen, 2015

## Art. 3956

Chair with sled base with writing tablet (right or left side) and shell upholstered in leather, faux leather, fabric or customer's material. Available glides with felt insert for wood floors.



### Dimensions \*

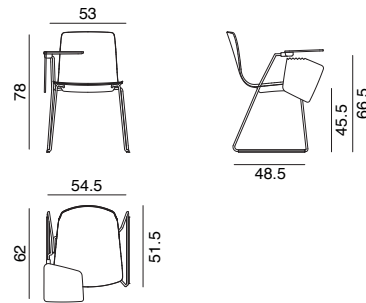

\* File CAD 2D - 3D available for download at [www.arper.com](http://www.arper.com)

### Frame Base



CRO

### Shell

#### Carded In

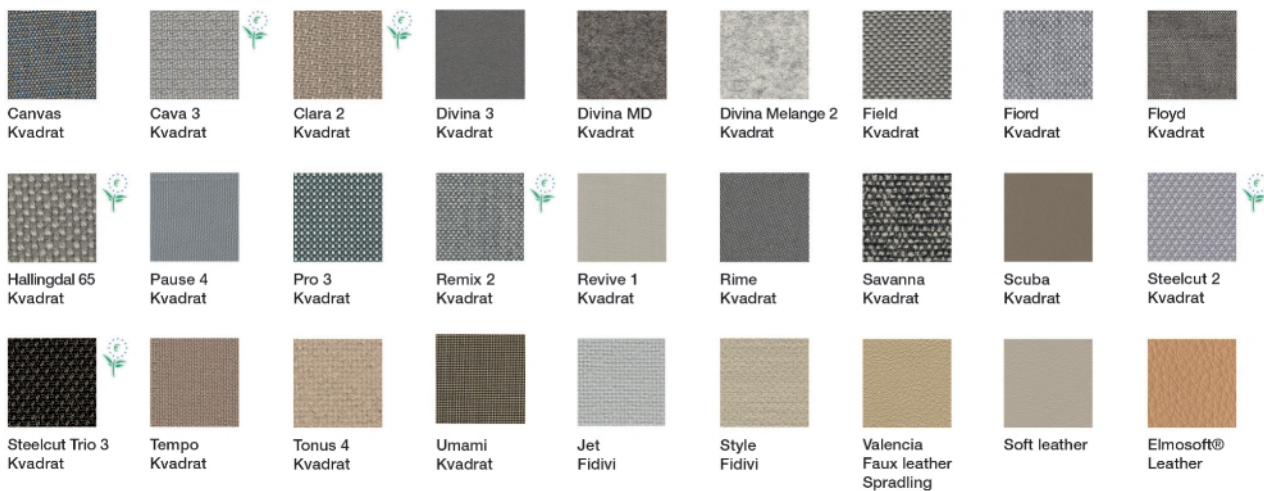

#### Graded In

**kvadrat**

**camira**



DESIGN  
TEX



**Gabriel**



**svensson**

**maharam**

**SergeFerrari**

# Aava

## Design by Antti Kotilainen, 2015

---

### Accessories:



Single trolley Art. 0500



Stacking protection Pad Art. 3950





Link Art. 3970

---

### SHIPMENT DETAILS

#### Art.3956

1 pz = 3  - kg 14,21/ m<sup>2</sup> 0,36

4 pz = 3  - kg 46,42/ m<sup>2</sup> 0,63

---

### TECHNICAL SPECIFICATIONS

#### Art.3956

COL requirement m<sup>2</sup> 1,56

H 140 cm. COM Meterage ml 0.99

---

### RESISTANCE TEST

---

### FIRE RETARDANT TEST

Classe 1IM Faux leather Valencia • California TB117-2013 Cava 3 Clara Canvas Divina MD Divina Melange 2 Divina 3 Soft leather Elmosoft Field Hallingdal 65 Jet Jumper 3 Pro 3 Soft leather Pause 4 Remix 2 Savanna Steelcut 2 Scuba Steelcut Trio 2 Steelcut Trio 3 Sunniva Sunniva 2 Tonus 4 Tempo Faux leather Valencia • BS5852 Sch. 4 Part 1 Faux leather Valencia • BS5852 Sch. 5 Part 1 Cava 3 Clara Canvas Divina MD Divina Melange 2 Divina 3 Soft leather Elmosoft Hallingdal 65 Soft leather Remix 2 Savanna Steelcut 2 Steelcut Trio 2 Steelcut Trio 3 Tonus 4 Faux leather Valencia

---

### ENVIRONMENTAL CERTIFICATIONS

---

### Stackability:

- Up to 6 pcs. (should the weight exceed 25 kilos a handling tool must be used).
- With trolley: up to 6 pcs.

arper

F +39 0422 791800

T +39 0422 7918

www.arper.com

# Aava

Design by Antti Kotilainen, 2015

## Art. 3967

Chair with steel sled base with writing tablet (right or left side) and polypropylene shell available in 6 colors. The shell is fitted with leather, faux leather, fabric or customer's material front upholstery. Glides with felt insert for wood floors are provided upon request without surcharge.



### Dimensions \*

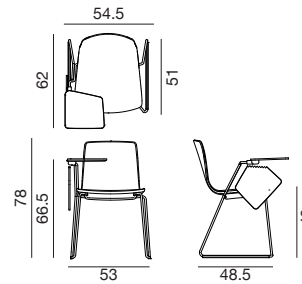

\* File CAD 2D - 3D available for download at [www.arper.com](http://www.arper.com)

### Frame Base



CRO

### Shell

#### Polypropylene

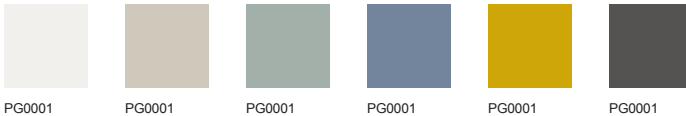

#### Carded In



#### Graded In

**kvadrat**

**camira**



DESIGN  
TEX



**Gabriel**



**svensson**

**maharam**

**Serge Ferrari**

# Aava

Design by Antti Kotilainen, 2015

---

## Accessories:



Single trolley Art. 0500



Stacking protection Pad Art. 3950



Link Art. 3970

---

## SHIPMENT DETAILS

### Art.3967

1 pz = 3 - kg 14,21/ m<sup>2</sup> 0,36

4 pz = 3 - kg 50,02/ m<sup>2</sup> 0,63

---

## TECHNICAL SPECIFICATIONS

### Art.3967

COL requirement m<sup>2</sup> 0.78

H 140 cm. COM Meterage ml 0.66

Frame base finishes: indoor use only

---

## RESISTANCE TEST

---

## FIRE RETARDANT TEST

Classe 1M Faux leather Valencia • California TB117-2013 Cava 3 Clara Canvas Divina MD Divina Melange 2 Divina 3 Soft leather Elmosoft Field Hallingdal 65 Jet Jumper 3 Pro 3 Soft leather Pause 4 Remix 2 Savanna Steelcut 2 Scuba Steelcut Trio 2 Steelcut Trio 3 Sunniva Sunniva 2 Tonus 4 Tempo Faux leather Valencia • BS5852 Sch. 4 Part 1 Faux leather Valencia • BS5852 Sch. 5 Part 1 Cava 3 Clara Canvas Divina MD Divina Melange 2 Divina 3 Soft leather Elmosoft Hallingdal 65 Soft leather Remix 2 Savanna Steelcut 2 Steelcut Trio 2 Steelcut Trio 3 Tonus 4 Faux leather Valencia

---

## ENVIRONMENTAL CERTIFICATIONS

---

## Stackability:

- Up to 6 pcs. (should the weight exceed 25 kilos a handling tool must be used).
- With trolley: up to 6 pcs.

arper

F +39 0422 791800

T +39 0422 7918

www.arper.com



# Aava

Design by Antti Kotilainen, 2015

## Art. 3971

Chair with steel sled base with writing tablet (right or left side) and polypropylene shell available in 6 colors. Glides with felt insert for wood floors are provided upon request without surcharge.



## Dimensions \*

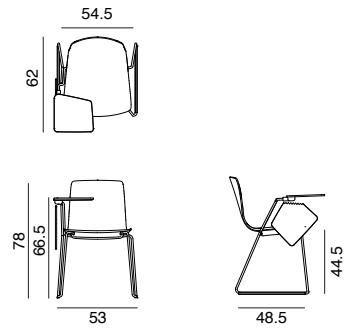

\* File CAD 2D - 3D available for download at [www.arper.com](http://www.arper.com)

## Frame Base



CRO

## Shell

### Polypropylene



PG0001

PG0001

PG0001

PG0001

PG0001

PG0001

arper

F +39 0422 791800

T +39 0422 7918

[www.arper.com](http://www.arper.com)

# Aava

Design by Antti Kotilainen, 2015

---

## Accessories:



Single trolley Art. 0500





Link Art. 3970

---

## SHIPMENT DETAILS

### Art.3971

1 pz = 2  - kg 12,45/ m<sup>3</sup> 0,30

4 pz = 3  - kg 41,72/ m<sup>3</sup> 0,56

---

### Stackability:

- Up to 6 pcs. (should the weight exceed 25 kilos a handling tool must be used).
- With trolley: up to 6 pcs.

arper

F +39 0422 791800

T +39 0422 7918

www.arper.com

# Aava

Design by Antti Kotilainen, 2016

## Art. 3987

Chair with steel sled base with writing tablet (right or left side) and curved plywood shell, veneered natural birchwood effect or lacquered birchwood effect in 4 different colors. Wood shell with seat cushion in leather, faux leather, fabric or customer's material upholstery. Glides with felt insert for wood floors are provided upon request without surcharge.



### Dimensions \*

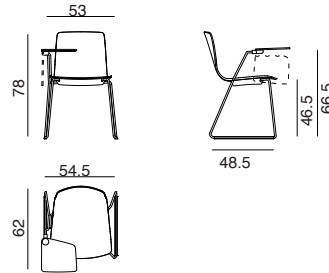

\* File CAD 2D - 3D available for download at [www.arper.com](http://www.arper.com)

### Frame Base



CRO

### Shell

#### Wood



L0009 L0010 L0011 L0012 L0013

#### Carded In



#### Graded In

**kvadrat**

**camira**



DESIGN  
TEX



**Gabriel**



**svensson**

**maharam**

**Serge Ferrari**

# Aava

## Design by Antti Kotilainen, 2016

---

### Accessories:



Single trolley Art. 0500



Link Art. 3941





Stacking protection Pad Art. 3942

---

### SHIPMENT DETAILS

#### Art.3987

1 pz = 3  - kg 14,0/ m<sup>3</sup> 0,362

4 pz = 3  - kg 44,22/ m<sup>3</sup> 0,606

---

### TECHNICAL SPECIFICATIONS

#### Art.3987

COL requirement m<sup>2</sup> 0.36

H 140 cm. COM Meterage ml 0.54

Frame base finishes: indoor use only

---

### Stackability:

- With stacking protection pad: up to 6 pcs. (should the weight exceed 25 kilos a handling tool must be used).
- With stacking protection pad and trolley: up to 6 pcs.

arper

F +39 0422 791800

T +39 0422 7918

www.arper.com

# Aava

Design by Antti Kotilainen, 2016

## Art. 3988

Chair with steel sled base with writing tablet (right or left side) and polypropylene shell available in 6 colors. Polypropylene shell with seat cushion in leather, faux leather, fabric or customer's material front upholstery. Glides with felt insert for wood floors are provided upon request without surcharge.



### Dimensions \*

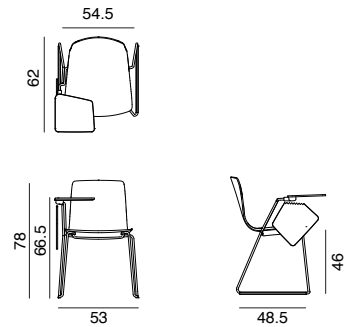

\* File CAD 2D - 3D available for download at [www.arper.com](http://www.arper.com)

### Frame Base



CRO

### Shell

#### Polypropylene

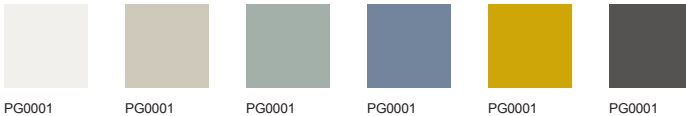

#### Carded In

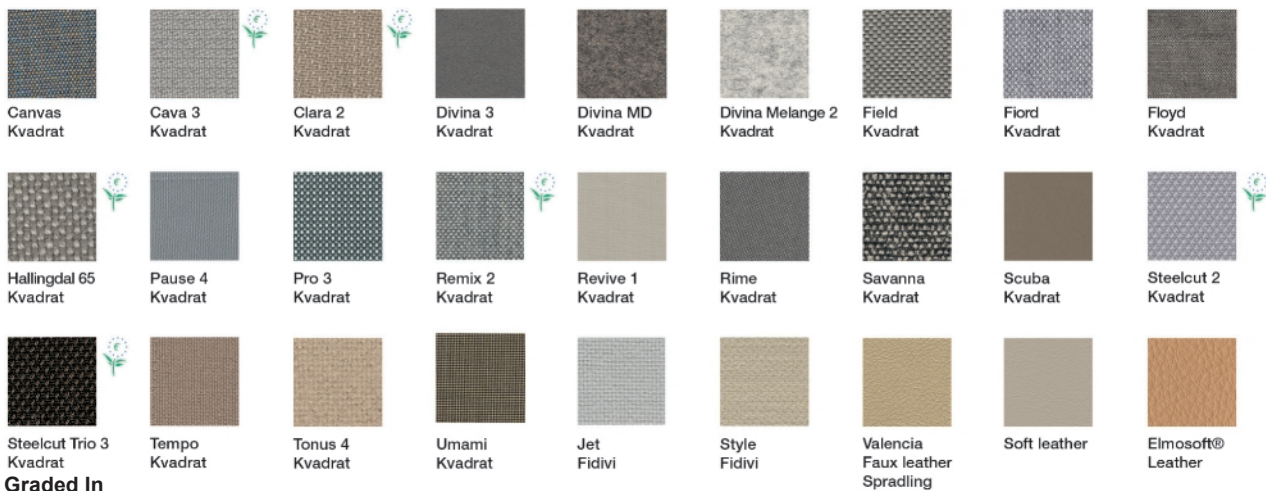

#### Graded In

**kvadrat**

**camira**



DESIGN  
TEX



**Gabriel**



**svensson**

**maharam**

**Serge Ferrari**

# Aava

## Design by Antti Kotilainen, 2016

---

### Accessories:



Stacking protection Pad Art.  
3950





Link Art. 3970

---

### SHIPMENT DETAILS

#### Art.3988

1 pz = 3  - kg 13,4/ m<sup>3</sup> 0,362

4 pz = 3  - kg 47,22/ m<sup>3</sup> 0,631

---

### TECHNICAL SPECIFICATIONS

#### Art.3988

COL requirement m<sup>2</sup> 0.36

H 140 cm. COM Meterage ml 0.54

Frame base finishes: indoor use only

---

### Stackability:

- With stacking protection pad: up to 6 pcs. (should the weight exceed 25 kilos a handling tool must be used).
- With stacking protection pad and trolley: up to 6 pcs.

arper

F +39 0422 791800

T +39 0422 7918

www.arper.com