

# Catifa 53

Design by Lievore Altherr Molina, 2001

## Art. 0207

Chair with chromed or powdercoated steel swivel trestle base and polypropylene matt single-colour or upholstered in hard leather grade 1 (CT) or hard leather grade 2. Polypropylene and steel armrests, are available upon request.



## Dimensions \*

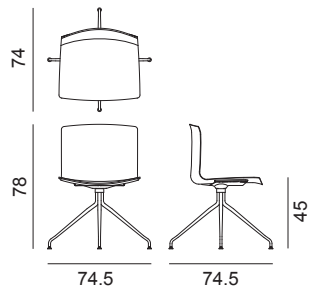

\* File CAD 2D - 3D available for download at [www.arper.com](http://www.arper.com)

## Frame Base

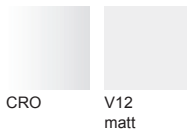

## Shell

### Polypropylene



PO  
Polypropylene  
one color

### Hard leather Grade 1 and Grade 2



CT CU

arper

F +39 0422 791800

T +39 0422 7918

[www.arper.com](http://www.arper.com)

# Catifa 53

Design by Lievore Altherr Molina, 2001

---

## Accessories:

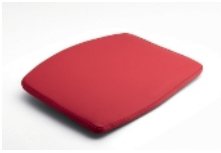

Cushion Art. 0231



Set of glides Art. 2015



Armrests BV





Armrests CV - pad (only for PO)

---

## SHIPMENT DETAILS

Art.0207

1 pz = 2  - kg 11,3/ m<sup>2</sup> 0,28

4 pz = 2  - kg 34,2/ m<sup>2</sup> 0,37

---

## RESISTANCE TEST

---

## FIRE RETARDANT TEST

BS5852/90 Sez.5 cigarette match polypropylene • BS5852 Sch. 5 Part 1  
CT CU

---

## ENVIRONMENTAL CERTIFICATIONS



arper

F +39 0422 791800

T +39 0422 7918

www.arper.com

# Catifa 53

Design by Lievore Altherr Molina, 2001

## Art. 0209

Chair with chromed or powdercoated steel swivel trestle base and shell upholstered in leather, faux leather, fabric or customer's material. Steel armrests, also upholstered, are available upon request.



### Dimensions \*

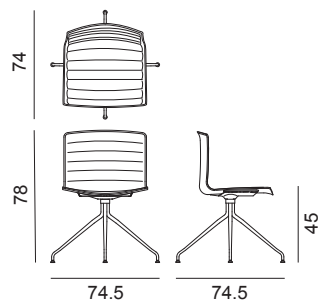

\* File CAD 2D - 3D available for download at [www.arper.com](http://www.arper.com)

### Frame Base



### Shell

#### Carded In

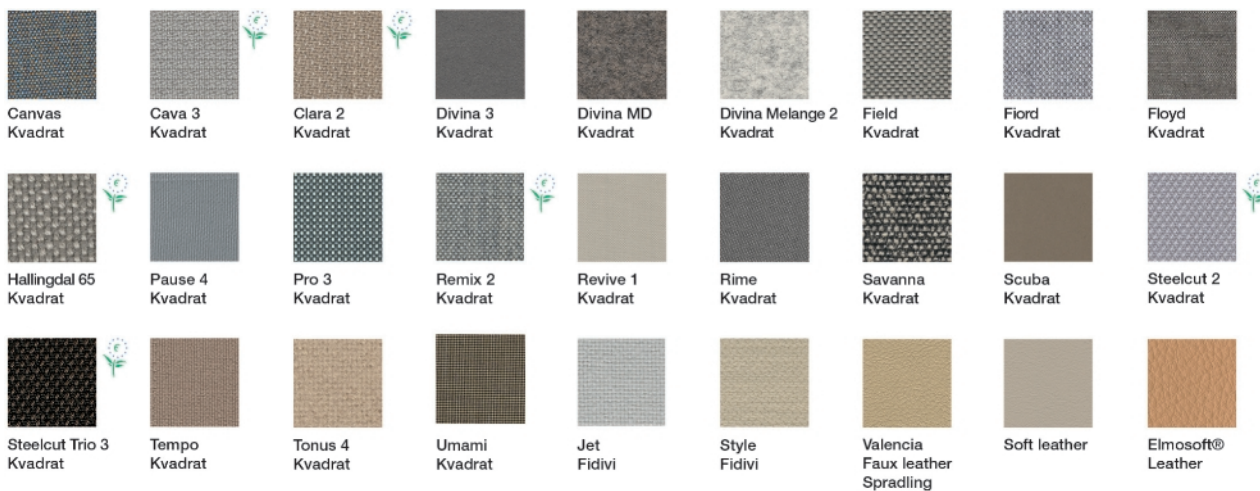

#### Graded In

**kvadrat**

**camira**



DESIGN  
TEX



**Gabriel**



**svensson**

**maharam**

**SergeFerrari**

# Catifa 53

Design by Lievore Altherr Molina, 2001

## Accessories:



Set of glides Art. 2015



Armrests BV



Armrests CI - only pad

## SHIPMENT DETAILS

### Art.0209

1 pz = 2 - kg 12,3/ m² 0,28  
4 pz = 2 - kg 38,6/ m² 0,41

## TECHNICAL SPECIFICATIONS

### Art.0209

COL requirement m² 1.78  
H 140 cm. COM Meterage ml 1.21  
Line detail stitching.

## RESISTANCE TEST

## FIRE RETARDANT TEST

BS5852 i.s. 5 Cava 3 Soft leather Elmosoft Hallingdal 65 Pro 3 Tonus 4 • Classe 1IM Cava 3 Divina MD Divina Melange 2 Divina 3 Hallingdal 65 Pro 3 Soft leather Tonus 4 Faux leather Valencia • California TB117-2013 Cava 3 Clara Canvas Divina MD Divina Melange 2 Divina 3 Soft leather Elmosoft Field Hallingdal 65 Jet Jumper 3 Pro 3 Soft leather Pause 4 Remix 2 Savanna Steelcut 2 Scuba Steelcut Trio 2 Steelcut Trio 3 Sunniva Sunniva 2 Tonus 4 Tempo Faux leather Valencia • BS5852 Sch. 4 Part 1 Cava 3 Divina MD Divina Melange 2 Divina 3 Soft leather Elmosoft Hallingdal 65 Pro 3 Tonus 4 Faux leather Valencia • BS5852 Sch. 5 Part 1 Cava 3 Clara Canvas Divina MD Divina Melange 2 Divina 3 Soft leather Elmosoft Hallingdal 65 Soft leather Remix 2 Savanna Steelcut 2 Steelcut Trio 2 Steelcut Trio 3 Tonus 4 Faux leather Valencia • EN 1021 - 1 Divina MD Divina Melange 2 Divina 3 Soft leather Elmosoft Field Hallingdal 65 Pro 3 Soft leather • EN 1021 - 2 Divina MD Divina Melange 2 Divina 3 Soft leather Elmosoft Field Hallingdal 65 Pro 3 Soft leather

## ENVIRONMENTAL CERTIFICATIONS



arper

F +39 0422 791800

T +39 0422 7918

www.arper.com

# Catifa 53

Design by Lievore Altherr Molina, 2001

## Art. 0243

Chair with chromed or powdercoated steel swivel trestle base. The wood shell is available in four finishes (natural oak, bleached oak, wengé, teak). Steel armrests are available upon request.



## Dimensions \*

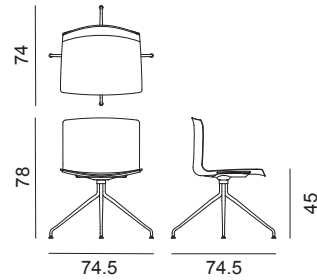

\* File CAD 2D - 3D available for download at [www.arper.com](http://www.arper.com)

## Frame Base



## Shell

### Wood

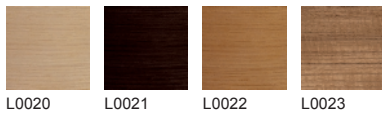

arper

F +39 0422 791800

T +39 0422 7918

[www.arper.com](http://www.arper.com)

# Catifa 53

Design by Lievore Altherr Molina, 2001

---

## Accessories:

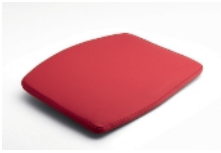

Cushion Art. 0231



Set of glides Art. 2015





Armrests BV

---

## SHIPMENT DETAILS

### Art.0243

1 pz = 2  - kg 11,32/ m<sup>2</sup> 0,28

4 pz = 2  - kg 34,18/ m<sup>2</sup> 0,38

---

## RESISTANCE TEST

---

## ENVIRONMENTAL CERTIFICATIONS



---

## TECHNICAL SPECIFICATIONS

---

## FIRE RETARDANT TEST

BS5852/90 Sez.5 cigarette match LG • Classe 1 LG

arper

F +39 0422 791800

T +39 0422 7918

www.arper.com

# Catifa 53

Design by Lievore Altherr Molina, 2001

## Art. 2042

Chair with chromed or powdercoated steel swivel trestle base and matt polypropylene shell with front upholstery in leather, faux leather, fabric or customer's material. Steel armrests, also upholstered, are available upon request.



### Dimensions \*

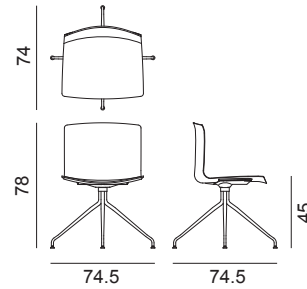

\* File CAD 2D - 3D available for download at [www.arper.com](http://www.arper.com)

### Frame Base



### Shell

#### Polypropylene



PO  
Polypropylene  
one color

#### Carded In



#### Graded In

**kvadrat**

**camira**



DESIGN  
TEX



**Gabriel**



**svensson**

**maharam**

**Serge Ferrari**

# Catifa 53

Design by Lievore Altherr Molina, 2001

## Accessories:



Set of glides Art. 2015



Armrests BV



Armrests CI - only pad

## SHIPMENT DETAILS

### Art.2042

1 pz = 2 - kg 13,1/ m<sup>2</sup> 0,28  
4 pz = 2 - kg 41,86/ m<sup>2</sup> 0,41

## RESISTANCE TEST

## ENVIRONMENTAL CERTIFICATIONS



## TECHNICAL SPECIFICATIONS

### Art.2042

COL requirement m<sup>2</sup> 0.84  
H 140 cm. COM Meterage ml 0.72

## FIRE RETARDANT TEST

BS5852 i.s. 5 Cava 3 Soft leather Elmosoft Hallingdal 65 Pro 3 Tonus 4 • Classe 1IM Cava 3 Divina MD Divina Melange 2 Divina 3 Hallingdal 65 Pro 3 Soft leather Tonus 4 Faux leather Valencia • California TB117-2013 Cava 3 Clara Canvas Divina MD Divina Melange 2 Divina 3 Soft leather Elmosoft Field Hallingdal 65 Jet Jumper 3 Pro 3 Soft leather Pause 4 Remix 2 Savanna Steelcut 2 Scuba Steelcut Trio 2 Steelcut Trio 3 Sunniva Sunniva 2 Tonus 4 Tempo Faux leather Valencia • BS5852 Sch. 4 Part 1 Cava 3 Divina MD Divina Melange 2 Divina 3 Soft leather Elmosoft Hallingdal 65 Pro 3 Tonus 4 Faux leather Valencia • BS5852 Sch. 5 Part 1 Cava 3 Clara Canvas Divina MD Divina Melange 2 Divina 3 Soft leather Elmosoft Hallingdal 65 Soft leather Remix 2 Savanna Steelcut 2 Steelcut Trio 2 Steelcut Trio 3 Tonus 4 Faux leather Valencia • EN 1021 - 1 Divina MD Divina Melange 2 Divina 3 Soft leather Elmosoft Field Hallingdal 65 Pro 3 Soft leather • EN 1021 - 2 Divina MD Divina Melange 2 Divina 3 Soft leather Elmosoft Field Hallingdal 65 Pro 3 Soft leather

arper

F +39 0422 791800

T +39 0422 7918

www.arper.com



# Catifa 53

Design by Lievore Altherr Molina, 2001

## Art. 2097

Chair with chromed or powdercoated steel swivel trestle base and double-curved wood shell available in four finishes (natural oak, bleached oak, wengé, teak), with front upholstery in leather, faux leather, fabric or customer's material. Steel armrests, also upholstered, are available upon request.



### Dimensions \*

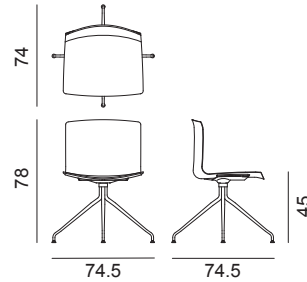

\* File CAD 2D - 3D available for download at [www.arper.com](http://www.arper.com)

### Frame Base



CRO

V12  
matt

### Shell

#### Wood



L0020

L0021

L0022

L0023

#### Carded In

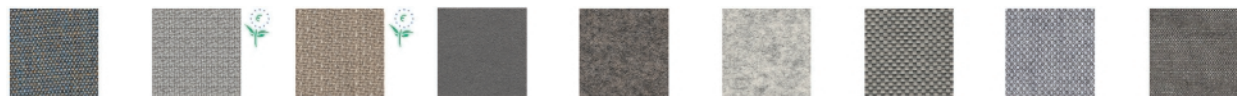

Canvas  
Kvadrat

Cava 3  
Kvadrat

Clara 2  
Kvadrat

Divina 3  
Kvadrat

Divina MD  
Kvadrat

Divina Melange 2  
Kvadrat

Field  
Kvadrat

Fiord  
Kvadrat

Floyd  
Kvadrat



Hallingdal 65  
Kvadrat

Pause 4  
Kvadrat

Pro 3  
Kvadrat

Remix 2  
Kvadrat

Revive 1  
Kvadrat

Rime  
Kvadrat

Savanna  
Kvadrat

Scuba  
Kvadrat

Steelcut 2  
Kvadrat



Steelcut Trio 3  
Kvadrat

Tempo  
Kvadrat

Tonus 4  
Kvadrat

Umami  
Kvadrat

Jet  
Fidivi

Style  
Fidivi

Valencia  
Faux leather  
Spradling

Soft leather

Elmosoft®  
Leather

#### Graded In

**kvadrat**

**camira**



DESIGN  
TEX



**Gabriel**



**svensson**

**maharam**

**Serge Ferrari**

# Catifa 53

Design by Lievore Altherr Molina, 2001

## Accessories:



Set of glides Art. 2015



Armrests BV



Armrests CI - only pad

## SHIPMENT DETAILS

### Art.2097

1 pz = 2 - kg 13,1/ m<sup>2</sup> 0,28  
4 pz = 2 - kg 41,86/ m<sup>2</sup> 0,41

## RESISTANCE TEST

## ENVIRONMENTAL CERTIFICATIONS



## TECHNICAL SPECIFICATIONS

### Art.2097

COL requirement m<sup>2</sup> 0.84  
H 140 cm. COM Meterage ml 0.72

## FIRE RETARDANT TEST

BS5852 i.s. 5 Cava 3 Soft leather Elmosoft Hallingdal 65 Pro 3 Tonus 4 • Classe 1IM Cava 3 Divina MD Divina Melange 2 Divina 3 Hallingdal 65 Pro 3 Soft leather Tonus 4 Faux leather Valencia • California TB117-2013 Cava 3 Clara Canvas Divina MD Divina Melange 2 Divina 3 Soft leather Elmosoft Field Hallingdal 65 Jet Jumper 3 Pro 3 Soft leather Pause 4 Remix 2 Savanna Steelcut 2 Scuba Steelcut Trio 2 Steelcut Trio 3 Sunniva Sunniva 2 Tonus 4 Tempo Faux leather Valencia • BS5852 Sch. 4 Part 1 Cava 3 Divina MD Divina Melange 2 Divina 3 Soft leather Elmosoft Hallingdal 65 Pro 3 Tonus 4 Faux leather Valencia • BS5852 Sch. 5 Part 1 Cava 3 Clara Canvas Divina MD Divina Melange 2 Divina 3 Soft leather Elmosoft Hallingdal 65 Soft leather Remix 2 Savanna Steelcut 2 Steelcut Trio 2 Steelcut Trio 3 Tonus 4 Faux leather Valencia • EN 1021 - 1 Divina MD Divina Melange 2 Divina 3 Soft leather Elmosoft Field Hallingdal 65 Pro 3 Soft leather • EN 1021 - 2 Divina MD Divina Melange 2 Divina 3 Soft leather Elmosoft Field Hallingdal 65 Pro 3 Soft leather

arper

F +39 0422 791800

T +39 0422 7918

www.arper.com

# Catifa 53

Design by Lievore Altherr Molina, 2013

## Art. 3123

Chair with chromed or powdercoated steel swivel trestle base and white polypropylene shell upholstered with a removable non-washable cover in leather, faux leather, fabric or customer's own material. The chair is provided already fitted with the cover. Steel armrests, also upholstered, are available upon request



### Dimensions \*

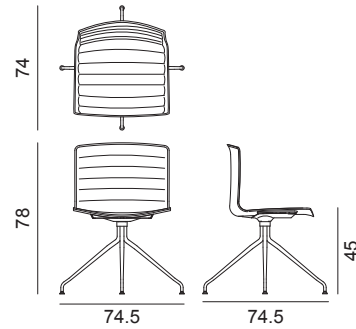

\* File CAD 2D - 3D available for download at [www.arper.com](http://www.arper.com)

### Frame Base



### Shell

#### Carded In

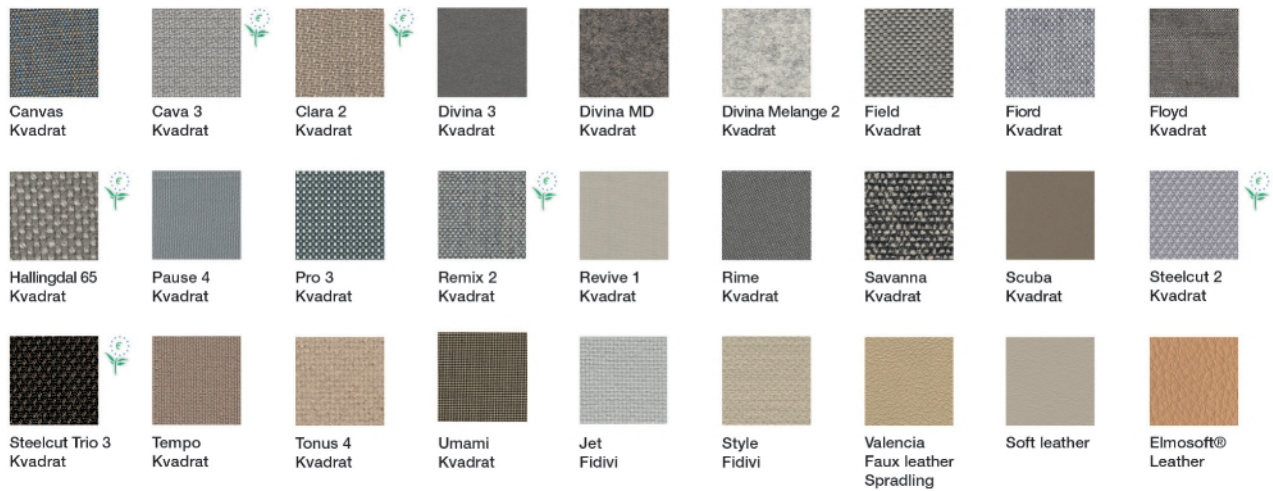

#### Graded In

**kvadrat**

**camira**



DESIGN  
TEX



**Gabriel**



**svensson**

**maharam**

**Serge Ferrari**

# Catifa 53

Design by Lievore Altherr Molina, 2013



Armrests BV



Armrests CI - only pad

## SHIPMENT DETAILS

### Art.3123

1 pz = 2  - kg 12,3/ m<sup>2</sup> 0,28

4 pz = 2  - kg 38,6/ m<sup>2</sup> 0,41

## TECHNICAL SPECIFICATIONS

### Art.3123

COL requirement m<sup>2</sup> 2,09

H 140 cm. COM Meterage ml 1,23

The cover stitching comes in the same color as the upholstery. Stitching on cover 1 and 3 comes in white or black, to customer's choice.

Surcharge for armrest CI upholstered.

## RESISTANCE TEST

## FIRE RETARDANT TEST

BS5852 i.s. 5 Cava 3 Soft leather Elmosoft Hallingdal 65 Pro 3 Tonus 4 • Classe 1M Cava 3 Divina MD Divina Melange 2 Divina 3 Hallingdal 65 Pro 3 Soft leather Tonus 4 Faux leather Valencia • California TB117-2013 Cava 3 Clara Canvas Divina MD Divina Melange 2 Divina 3 Soft leather Elmosoft Field Hallingdal 65 Jet Jumper 3 Pro 3 Soft leather Pause 4 Remix 2 Savanna Steelcut 2 Scuba Steelcut Trio 2 Steelcut Trio 3 Sunniva Sunniva 2 Tonus 4 Tempo Faux leather Valencia • BS5852 Sch. 4 Part 1 Cava 3 Divina MD Divina Melange 2 Divina 3 Soft leather Elmosoft Hallingdal 65 Pro 3 Tonus 4 Faux leather Valencia • BS5852 Sch. 5 Part 1 Cava 3 Clara Canvas Divina MD Divina Melange 2 Divina 3 Soft leather Elmosoft Hallingdal 65 Soft leather Remix 2 Savanna Steelcut 2 Steelcut Trio 2 Steelcut Trio 3 Tonus 4 Faux leather Valencia • EN 1021 - 1 Divina MD Divina Melange 2 Divina 3 Soft leather Elmosoft Field Hallingdal 65 Pro 3 Soft leather • EN 1021 - 2 Divina MD Divina Melange 2 Divina 3 Soft leather Elmosoft Field Hallingdal 65 Pro 3 Soft leather

## ENVIRONMENTAL CERTIFICATIONS



arper

F +39 0422 791800

T +39 0422 7918

www.arper.com